

# VEROTEC

Electronics Packaging

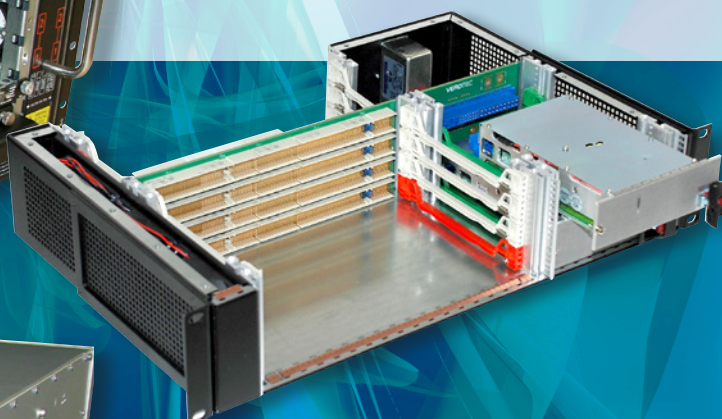

Integrated  
Systems

## CUSTOM INTEGRATED SYSTEMS

TecServ+ is the vehicle by which Verotec delivers its value added services. These fall within 5 main categories and are described below. When it comes to integrated systems, we've worked with many customers in the past to design, manufacture and help bring to market modified and custom versions of our standard products – a small selection of these are pictured below. If you have any special integrated system requirements, please contact our sales office



### ENGINEERING SERVICES:

- + Complete review of commercial, electro-mechanical, environmental and regulatory product requirements with customer.
- + Import of STEP, IGES, DWG & DXF file formats
- + Mechanical and electrical design using latest CAD software
- + 3D Modelling to allow conceptual testing before production
- + Component selection from a vast library of parts

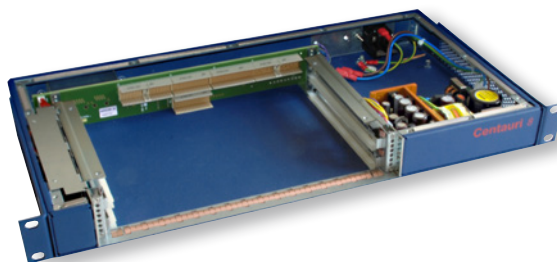

**Customised H12 chassis, painted blue with special backplane and high EMC - video streaming application**

### MANUFACTURING SERVICES:

- + Prototype / pre-production samples using small batch shop
- + Modification of standard catalogue products (including machining, CNC punching, laser cutting, painting & silk-screening)
- + Manufacture of custom / bespoke products (including fabrication, machining, CNC punching, plating, painting & silk-screening)
- + Assembly & kitting of components
- + Integration & mechanical / electrical testing of complex systems



**Customised V4 CompactPCI half-width chassis with front DC input panel - industrial process control application.**

### COMPLIANCE SERVICES:

- + Validation of product design and/or specification
- + Advice on environment legislation (RoHS, Reach, Weee etc.)
- + In-house pre-compliance testing for CE marking (Safety, EMC)
- + Supply of product technical construction file
- + Testing & certification of a product at an approved test house (for EMC, shock & vibration, altitude, temperature, humidity etc.)



**Customised V9 VME64x chassis, recessed with high airflow and 160/220mm split card cage - military application.**

### LOGISTICAL SERVICES:

- + Express manufacturing service for quick turnaround of urgent orders
- + Special / bespoke packaging for safe transport of goods
- + Scheduled orders (including JIT and KAN BAN systems)
- + Stock holding & distribution
- + Exporting (including export packaging, land/sea/air transportation, freight forwarding, customs documentation & shipping manifests)

### PROJECT MANAGEMENT SERVICES:

- + Initial project consultation
- + Capability and feasibility study
- + Estimation of project cost and leadtime
- + Management of design process (specification to validation)
- + Management of manufacturing process (prototype to production)
- + Cost reduction programmes throughout product life cycle



**Customised D10 VPX chassis with cooling plinth and rear DC input panel - digital signal processing application.**

## INTRODUCTION

Verotec offer a number of standard COTS (Commercial off-the-shelf) integrated systems to address the needs of today's varied industrial computing demands. For VME64/VPX and CompactPCI platforms, we offer our Type H, Type D, Type V chassis', each with its own unique form-factor and configuration options. For desktop VPX software & hardware development we offer our TecSYS chassis and for next-generation carrier grade telecoms applications we offer the A6R ATCA system.

### TYPE H (HORIZONTAL)

Designed for the horizontal mounting of 6U cPCI or VME64x boards, the range consists of three base models; H12 (1U/2 slot), H24 (2U/4 slot) and H36 (3U/6 slot). All are 19" rack-mounting and incorporate the KM6-HD (Heavy Duty) subrack system. They are fully IEEE1101.10/11 compliant and support rear transition modules. Features include optimized cooling schemes, embedded or pluggable power supplies and RFI shielding.

### TYPE D (DESKTOP)

The Type D system is a desktop solution for housing primarily 6U VME64x or CompactPCI boards, although versions for 3U cards can be easily specified. There are two variants; D10 (half width / 10 slot) and D21 (full width / 21 slot). Both are 9U high (6U high for 3U board version) and incorporate a 60mm recessed card cage for cable management. Type D systems use the IEEE1101.10/11 compliant KM6-RF subrack system and feature a removable, filtered fan tray & rear transition card area as standard.

### TYPE V (VERTICAL)

The Type V chassis provides a 19" rack-mounting solution for vertically mounted, 3U & 6U VMEbus, VME64x & CompactPCI cards. There are four base models; V4, V8, V9 & V12, where the number denotes the unit of height (U) of the chassis. All offer an 84HP (21 slot) card area with the V4 catering for 3U cards (plus 1U fantray) and the others designed for 6U cards. Features include IEC 60297 & IEEE 1101.10/11 compliant subracks, removable, filtered fan trays, rear transition card areas, front panel status indicators and a choice of embedded or pluggable power supplies.

### TECSYS (DEVELOPMENT)

The VPX specification offers a whole new level of performance. However with no legacy systems around, developers needed a platform to start working from. The TecSYS offers a flexible entry-level solution, with a 5 slot 3U full mesh X4 PCI Express VITA 46.4 backplane in the versatile Diplomat enclosure. The TecSYS chassis is suitable for use in the development environment and for demonstration or target systems.

### A6R (ATCA)

ATCA offers high bandwidths as well as improved reliability, availability and serviceability. Although originally designed for next generation "carrier" grade communications equipment, it is often considered in other markets & applications such as military, medical & scientific.

The AR6 chassis is a 6U, 6 slot, 19" rack mounting ATCA shelf that is powerful and highly configurable, making it suitable for both development and deployed applications. It's versatile and scalable design in terms of system management, cooling, power and backplane topology means it can be used for anything from a simple laboratory / test unit to a high-availability / mission critical system

### CONTENTS:

Type	Platform	Page
H12	VME64x & CompactPCI	Page 13.04-13.05
H24	VME64x & CompactPCI	Page 13.06-13.07
H36	VME64x & CompactPCI	Page 13.08-13.09
D10	VME64x & CompactPCI	Page 13.10-13.11
D21	VME64x & CompactPCI	Page 13.12-13.13
V4	CompactPCI	Page 13.14-13.15
V8	VMEbus	Page 13.16-13.17
V9	VME64x & CompactPCI	Page 13.18-13.19
V12	VME64x & CompactPCI	Page 13.20-13.21
TecSYS	VPX	Page 13.22-13.23
A6R	ATCA	Page 13.24-13.25
BESPOKE SYSTEMS		Page 13.26

Type H



Type D



Type V



TecSYS



A6R



## INTRODUCTION

Designed for use in either 19" rackmount or desktop applications, the H12 chassis is Verotec's slimmest horizontal chassis. Fully compliant to IEEE 1101.10/11, the chassis is ideal for housing either VME64x or CompactPCI cards in low board count applications while still maintaining a full width rear transition capability. It is ideal for development or target/deployable systems requiring minimum space with its robust yet cost-effective design. System cooling is optimised for efficiency with a push-pull configuration, providing sufficient cooling for the demanding requirements of the latest CPU boards when used in a 1U form factor system. The top cover can easily be removed to provide excellent access, ideal for testing and development activities.

## THERMAL MANAGEMENT

The system airflow for the cards is from right to left, using a push-pull configuration. Three exhaust fans are fitted on the left hand side, covering both the front and rear card cages, while two fans draw air from the front and right hand side. Each fan is rated at 7.5 cfm in free air, providing the board cooling while the PSU is fitted with its own cooling fan, exhausting to the rear of the unit.

## POWER SUPPLY

Fitted with an autoranging ATX style embedded power supply with active Power Factor Correction, which is capable of providing a combined 110W on the 5V and 3.3V rails while offering full short circuit and over voltage protection. A front panel on/off switch is also provided.

## EMC

Good EMC shielding is achieved by adopting proven design practices. These include conductive fabric-over-foam gaskets on fixed seals and Beryllium Copper gaskets on the card cage apertures. The airflow vent patterns are 3.5mm round holes on a 5mm triangular pitch.

## BACKPLANE

The chassis is available with either a CompactPCI or VME64 extensions backplane. The CPCI option is a 6U, 2 slot, 64 bit, PICMG2.0 R3.0 compliant backplane with a right-hand system slot (top of system), with rear plug-up connectors in P3, P4 & P5 and selectable coded I/O voltage (default = 5V). The VME64x version is a 2 slot ANSI/VITA 1.1 - 1997 compliant backplane fitted with active on-board termination, electronic ABG (auto bus grant) and centre P0/J0 connectors fitted.

## FEATURES

- 1U Chassis
  - Rackmount or Desktop operation (removable rack ears)
  - Removable top cover
- IEEE 1101.10/11 Heavy Duty Cardframe
  - 1U x 24HP x 160mm Front area
  - 1U x 24HP x 80mm Rear transition area
- 6U, 2 Slot Backplane (VME64x or CompactPCI)
  - ANSI/VITA 1.1-1997 VME Extensions B/P
  - PICMG 2.0 Revision 3.0 CPCI B/P
- 250W Embedded ATX Power Supply
  - Autoranging 110 - 240VAC input
  - Active Power Factor Correction
  - 110W @+5V & 3.3V combined
  - Front mounted On/Off switch
- Optimized fan cooling
  - Six low-noise DC fans
  - 22 CFM Total chassis airflow

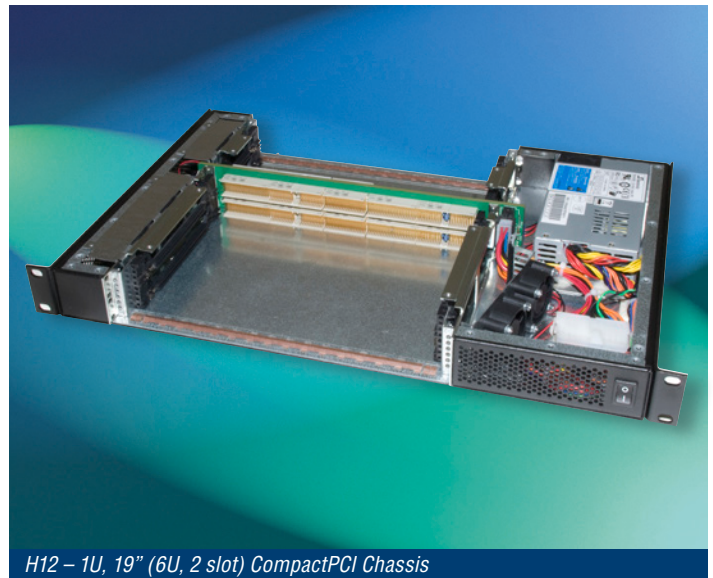

H12 - 1U, 19" (6U, 2 slot) CompactPCI Chassis



Front View



Rear View

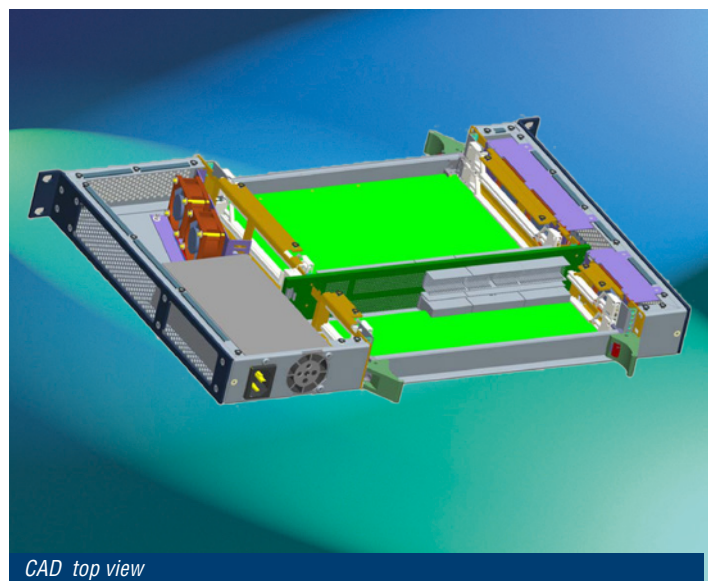

CAD top view

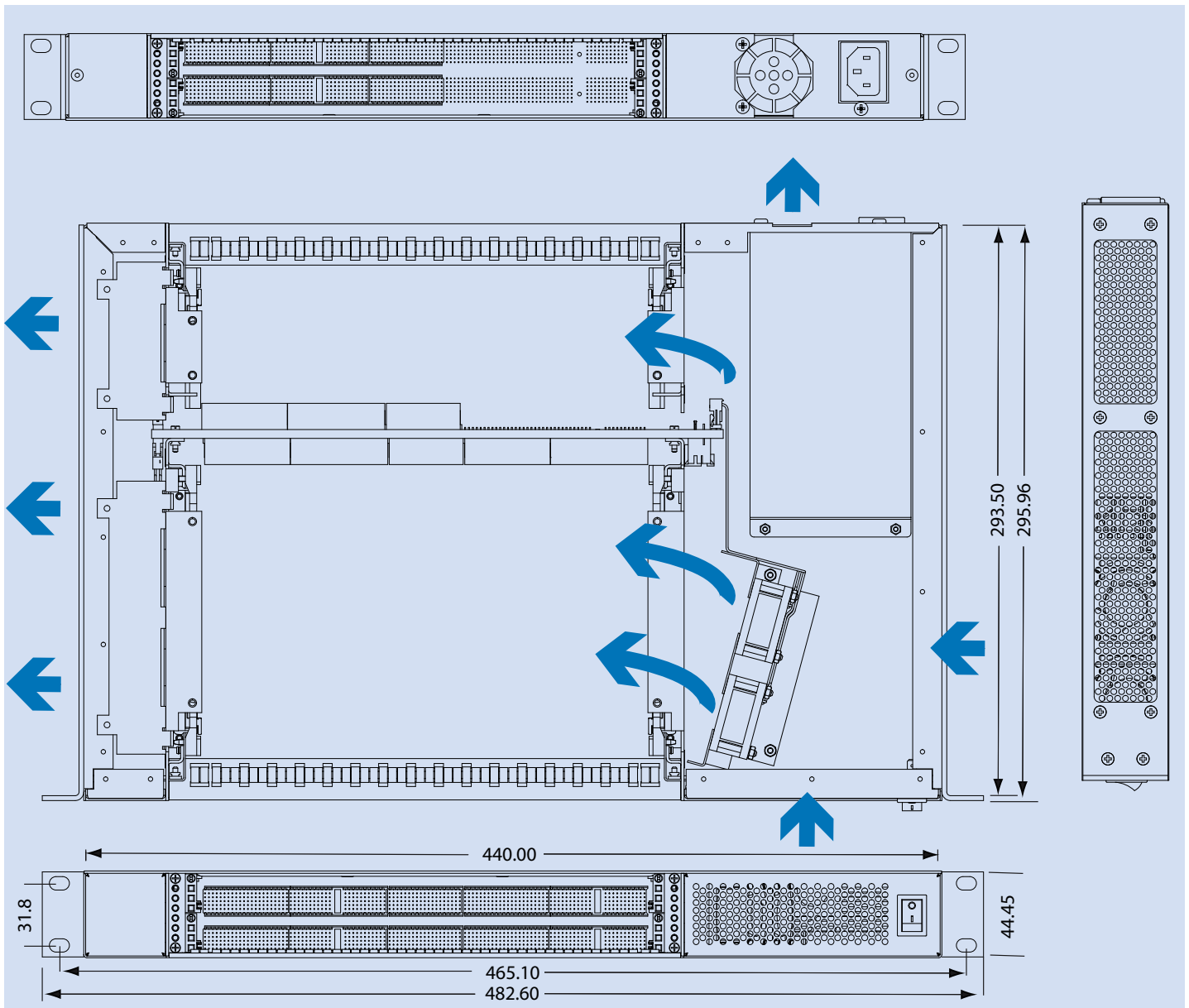

## SPECIFICATION

### Dimensions

Width	440mm / 17.33" desktop
	482.6mm / 19" with rackmount ears
Depth	296mm / 11.65"
Height	1U / 44.45mm / 1.75"

### Weight

4.47 Kg / 9.86 lbs

### Material & Finish

Outer - Steel (Powder coated in black – textured finish)  
 EMC Gasket – Beryllium / Copper  
 Subrack - Aluminium alloy (Iridite NCP)

### Environmental

Operating Temperature	0°C to +50°C
Storage Temperature	-20°C to +80°C
Airflow	22 CFM / 37 m <sup>3</sup> /hr.

### Power Supply

Input	110 to 240V @ 50-60 Hz
Output	+5V @ 17A*
	+3.3V @ 14A*
	+12V @ 3A
	-12V @ 0.8A

\* Total combined power 110W

## ORDERING INFORMATION

Description	
1U VME64x Chassis	141-2211120
1U CompactPCI Chassis	141-2211150

## CUSTOMIZING OPTIONS

**Please Note** – With a wide range of options available, it would be impossible to list every combination. Should your application require a different specification such as backplane, cooling or power supply variants, please contact us to discuss.

# H24 - 2U Compact PCI / VME64x Chassis

## INTRODUCTION

The H24 chassis is designed as a 2U x 19" x 300mm deep rackmount or desktop enclosure offering 4 x 6U horizontal 4HP slots along with provision for a full width rear transition area making it ideal for either CPCI or VME64x applications. Fully compliant with the IEEE 1101.10/11 specification, the flexibility of this design means it can be configured with a wide range of power supply options. These range from a single 250W embedded power supply or up to two pluggable PICMG 2.11 compliant 300W AC/DC or DC/DC power supplies with hot-swap capability, making this an ideal platform for high availability systems. Alternatively, part of the PSU bay may be configured for multiple HDD (Hard Disk Drive) positions. Optimised cooling is provided by three large DC fans in a fixed or removable tray providing airflow flow through vented side panels.

## THERMAL MANAGEMENT

Airflow through the unit flows from left to right when viewed from the front, and is provided by three 80mm long life ball-bearing low-noise DC fans contained in a fixed or removable cassette module installed on the left hand side, adjacent to the subrack. The fan cassette can be fitted with optional filter material. Positioning of the fans ensures cooling is directed to the daughter boards and to the RTM area as well as the PSU. When fitted with an embedded ATX style power supply, the PSU built-in fan is exhausted to the rear of the chassis.

## POWER SUPPLY OPTIONS

The system can be configured with an extensive range of PSU options, including both AC and DC inputs; a single 250W embedded ATX style PSU or space for up to two AC or DC 3U x 8HP PICMG 2.11 compatible power supplies in either 200 or 300W configurations. These power factor corrected supplies can be configured as load-sharing or redundant operation for use in high availability applications. The modules are pluggable type, featuring two separate converters, this allows the supply to provide 5V and 3.3V at their maximum rating simultaneously.

## EMC

Good EMC shielding is provided by adopting proven design practices. These include conductive fabric-over-foam gaskets on fixed seals and Beryllium Copper gaskets on the card cage apertures. The airflow vent patterns are 3.5mm round holes on a 5mm triangular pitch. A rear mounted filtered IEC power inlet (switched & fused) is designed to control conducted noise to EN55022 level B when used with modular power supplies.

## BACKPLANE

Ideal for both CPCI and VME64x applications, the chassis is available with a range of backplane options. The CPCI options include a 6U, 4 slot, 64 bit, PICMG2.0 R3.0 compliant backplane with a right-hand system slot (top of system), with rear plug-up connectors in P3, P4 & P5 and selectable coded I/O voltage (default = 5V). Options include CT/H.110 (Computer Telephony) version, or PICMG 2.16 (packet switching) backplanes. The VME64x version is a 6 slot ANSI/VITA 1.1 - 1997 compliant backplane fitted with active on-board termination, electronic ABG (auto bus grant) and with centre P0/P0 connectors fitted.

## FEATURES

- 2U Chassis
  - Rackmount or Desktop operation (removable rack ears)
  - Removable top cover
- IEEE 1101.10/11 Heavy Duty Cardframe - KM6-HD Series'
  - 6U x 16HP x 160mm Front area
  - 6U x 16HP x 80mm Rear transition area
- 6U, 4 Slot Backplane (VME64x or CompactPCI)
  - ANSI/VITA 1.1-1997 VME Extensions B/P
  - PICMG 2.0 Revision 3.0 CPCI B/P
    - Optional CT/H.110 Bus (PICMG 2.5)
    - PICMG 2.16 Packet Switching B/P
- Wide range of PSU options
  - 250W embedded ATX style
  - Single or dual pluggable supplies
  - AC or DC input options
  - Hot swap / redundancy capability
- Optimized fan cooling
  - 3 x low-noise ball bearing DC fans
  - Fixed or hot swappable, front loading cassette
  - Optional filtering
  - Optional fan fail indication / monitoring
- Provision for mounting 3.5" drive peripherals



H24 - 2U, 19" (6U, 4 slot) CompactPCI Chassis

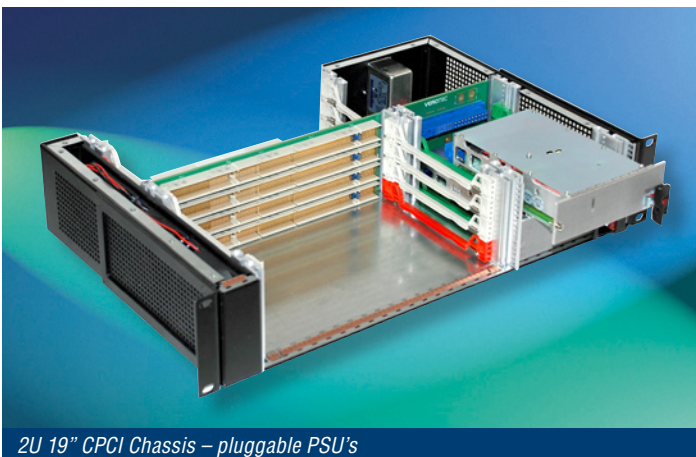

2U 19" CPCI Chassis - pluggable PSU's



Rear View

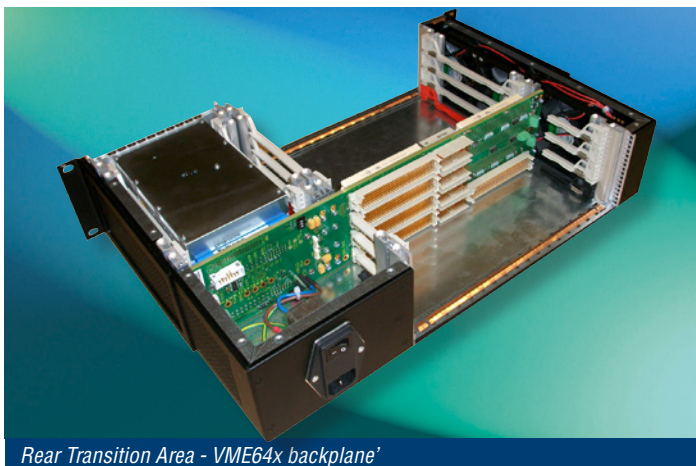

Rear Transition Area - VME64x backplane'

## CUSTOMIZING OPTIONS

Please Note - With a wide range of options available, it would be impossible to list every combination. Should your application require a different specification such as backplane, cooling or power supply variants, please contact us to discuss.

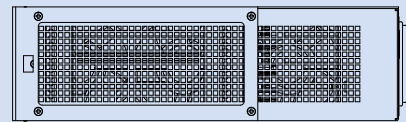
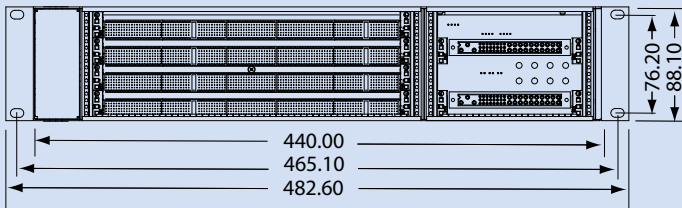
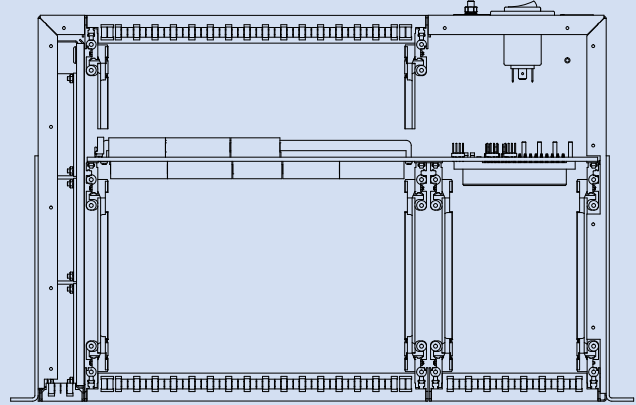
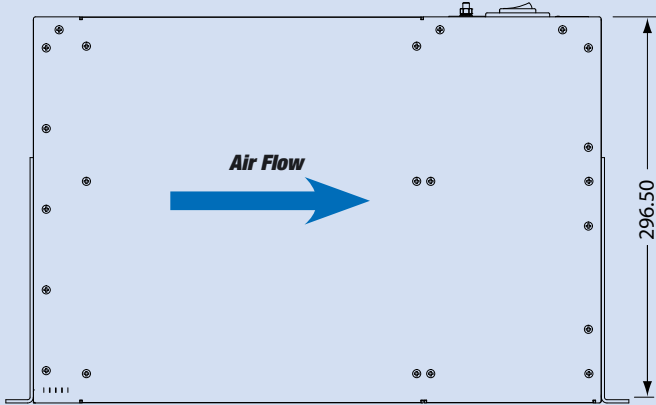
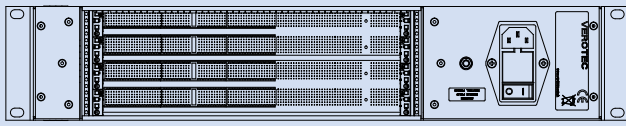

## SPECIFICATION

### Dimensions

Width	440mm / 17.33" desktop
	482.6mm / 19" with rackmount ears
Depth	296mm / 11.65"
Height	2U / 88.14mm / 3.57"

### Weight

6 Kg / 13.3 lbs (Typical, chassis + backplane + single PSU)

### Material & Finish

Outer - Steel (Powder coated in black – textured finish)  
 EMC Gasket – Beryllium / Copper  
 Subrack - Aluminium alloy (Iridite NCP)

### Environmental (Pluggable PSU)

Operating Temperature	-5°C to +55°C (PSU de-rating above)
Storage Temperature	-10°C to +70°C

### Power Supply

	Embedded	Pluggable 200W (each)	Pluggable 300W (each)
AC Input	110 to 240V @ 50-60 Hz	90 – 264 V @ 50-60 Hz	90 – 264 V @ 50-60 Hz
DC Input	36-72V DC	36-72V DC	36-72V DC
Output	+5V @ 17A	+5V @ 25A	+5V @ 30A
	+3.3V @ 14A	+3.3V @ 36A	+3.3V @ 40A
	+12V @ 3A	+12V @ 5A	+12V @ 5A
	-12V @ 0.8A	-12V @ 0.5A	-12V @ 1A

## ORDERING INFORMATION

<b>1</b>	<b>4</b>	<b>1</b>	<b>-</b>	<b>2</b>	<b>4</b>	<b>X</b>	<b>X</b>	<b>X</b>	<b>X</b>	<b>1</b>
FANS										
						2				
						3				
						4				
POWER - INPUT										
							1			
							2			
POWER - OUTPUT										
								1		
								2		
								3		
								4		
								5		
BACKPLANE										
									2	
									5	
									6	
									7	

NUMBER OF SLOTS = 4

## SPARES - ORDERING INFORMATION

Description	Part Number
2U Fan cassette 12V	447-4003626
2U Filter material	447-4003628
Hard Disk Drive Caddy 2.5" – 4HP	950-4002633
DC - 200W Power Supply	925-4004122
AC - 200W Power Supply	925-4004121
DC - 300W Power Supply	925-4004125
AC - 300W Power Supply	925-4004124

## INTRODUCTION

The H36 chassis is designed as a 3U x 19" x 300mm deep rackmount or desktop enclosure offering 6 x horizontal 4HP slots along with provision for a full width rear transition area making it ideal for either CPCI or VME64x applications. Fully compliant with the IEEE 1101.10/11 specification, the flexibility of this design means it can be configured with a wide range of power supply options. These range from a single 250W embedded power supply or up to 3 x pluggable PICMG 2.11 compliant 300W AC/DC or DC/DC power supplies with hot-swap capability, making this an ideal platform for high availability systems. Alternatively, part of the PSU bay may be configured for multiple HDD (Hard Disk Drive) positions. Optimised cooling is provided by two large DC fans in a fixed or removable tray providing airflow flow through vented side panels.

## THERMAL MANAGEMENT

Airflow through the unit flows from left to right when viewed from the front, and is provided by two 120mm long life ball-bearing low-noise DC fans contained in a fixed or removable cassette module installed on the left hand side, adjacent to the subrack. The fan cassette can be fitted with optional filter material. Positioning of the fans ensures cooling is directed to the daughter boards and to the RTM area as well as the PSU. When fitted with an embedded ATX style power supply, the PSU built-in fan is exhausted to the rear of the chassis.

## POWER SUPPLY OPTIONS

The system can be configured with an extensive range of PSU options, including both AC and DC inputs; a single 250W embedded ATX style PSU or space for up to three AC or DC 3U x 8HP PICMG 2.11 compatible power supplies in either 200 or 300W configurations. These power factor corrected supplies can be configured as load-sharing or redundant operation for use in high availability applications. The modules are pluggable type, featuring two separate converters; this allows the supply to provide 5V and 3.3V at their maximum rating simultaneously.

## EMC

Good EMC shielding is provided by adopting proven design practices. These include conductive fabric-over-foam gaskets on fixed seals and Beryllium Copper gaskets on the card cage apertures. The airflow vent patterns are 3.5mm round holes on a 5mm triangular pitch. A rear mounted filtered IEC power inlet (switched & fused) is designed to control conducted noise to EN55022 level B when used with modular power supplies.

## BACKPLANE

The chassis is available with a range of backplane options, covering both CPCI and VME64x architectures. The CPCI options include a 6U, 6 slot, 64 bit, PICMG2.0 R3.0 compliant backplane with a right-hand system slot (top of system), with rear plug-up connectors in P3, P4 & P5 and selectable coded I/O voltage (default = 5V). Options include CT/H.110 (Computer Telephony) version, or PICMG 2.16 (packet switching) backplanes. The VME64x version is a 6 slot ANSI/VITA 1.1 – 1997 compliant backplane fitted with active on-board termination, electronic ABG (auto bus grant) and centre P0/J0 connectors fitted.

## FEATURES

- 3U Chassis
  - Rackmount or Desktop operation (removable rack ears)
  - Removable top cover
- IEEE 1101.10/11 Heavy Duty Cardframe - KM6-HD Series'
  - 6U x 24HP x 160mm Front area
  - 6U x 24HP x 80mm Rear transition area
- 6U, 6 Slot Backplane (VME64x or CompactPCI)
  - ANSI/VITA 1.1-1997 VME Extensions B/P
  - PICMG 2.0 Revision 3.0 CPCI B/P
    - Optional CT/H.110 Bus (PICMG 2.5)
    - PICMG 2.16 Packet Switching B/P
- Wide range of PSU options
  - 250W embedded ATX style
  - Single or dual pluggable supplies
  - AC or DC input options
  - Hot swap / redundancy capability
- Optimized fan cooling
  - 2 x low-noise ball bearing DC fans
  - Fixed or hot swappable, front loading cassette
  - Optional filtering
  - Optional fan fail indication / monitoring
- Provision for mounting 3.5" drive peripherals



3H36 - 3U, 19" (6U, 6 slot) VME64x Chassis



Front View



Rear View

## CUSTOMIZING OPTIONS

Please Note – With a wide range of options available, it would be impossible to list every combination. Should your application require a different specification such as backplane, cooling or power supply variants, please contact us to discuss.



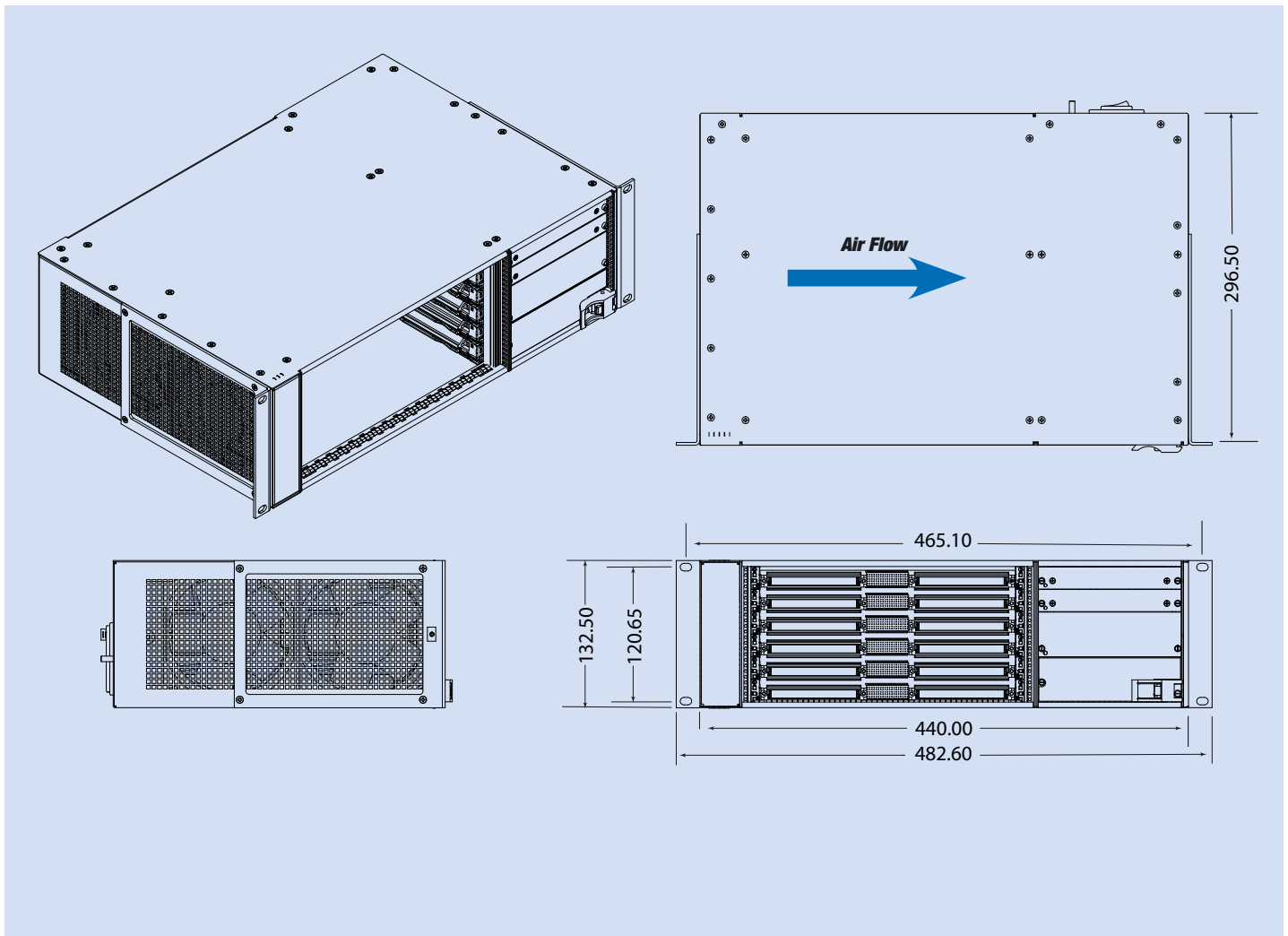

## SPECIFICATION

### Dimensions

Width	440mm / 17.33" desktop
or	482.6mm / 19" with rackmount ears
Depth	296mm / 11.65"
Height	3U / 132.50mm / 5.22"

### Weight

7.0 Kg / 15.4 lbs (Typical, chassis + backplane + single PSU)

### Material & Finish

Outer - Steel (Powder coated in black – textured finish)  
 EMC Gasket – Beryllium / Copper  
 Subrack - Aluminium alloy (Iridite NCP)

### Environmental

Operating Temperature	-5°C to +55°C (PSU de-rating above)
Storage Temperature	-10°C to +70°C

### Power Supply

	Embedded	Pluggable 200W (each)	Pluggable 300W (each)
AC Input	110 to 240V @ 50-60 Hz	90 – 264 V @ 50-60 Hz	90 – 264 V @ 50-60 Hz
DC Input	36-72V DC	36-72V DC	36-72V DC
Output	+5V @ 17A	+5V @ 25A	+5V @ 30A
	+3.3V @ 14A	+3.3V @ 36A	+3.3V @ 40A
	+12V @ 3A	+12V @ 5A	+12V @ 5A
	-12V @ 0.8A	-12V @ 0.5A	-12V @ 1A

## ORDERING INFORMATION

<b>1</b>	<b>4</b>	<b>1</b>	<b>-</b>	<b>2</b>	<b>6</b>	<b>X</b>	<b>X</b>	<b>X</b>	<b>X</b>	<b>3</b>
FANS _____										
Fixed										
Removable (Hot swap)										
Removable (Hot swap) + filtered										
POWER - INPUT _____										
AC Operation										
DC Operation (48V)										
POWER - OUTPUT _____										
Single 250W embedded										
Single 200W pluggable										
Double 200W pluggable										
Single 300W pluggable										
Double 300W pluggable										
BACKPLANE _____										
VME64x Extensions (With P0)										
Standard CompactPCI (PICMG 2.0 R.3)										
CPCI + Computer Telephony H110 (PICMG 2.5)										
CPCI + Packet Switching (PICMG 2.16)										

NUMBER OF SLOTS = 6

### SPARES - ORDERING INFORMATION

Description	Part Number
3U Fan cassette 12V	447-4003627
3U Filter material	447-4003629
Hard Disk Drive Caddy 2.5" – 4HP	950-4002633
DC - 200W Power Supply	925-4004122
AC - 200W Power Supply	925-4004121
DC - 300W Power Supply	925-4004125
AC - 300W Power Supply	925-4004124

# D10 – Desktop IO slot (Half-width) System

## INTRODUCTION

Designed as a 9U, half width x 422mm deep desktop enclosure, the D10 chassis offers up to 10 vertically mounted 6U x 160mm CPCI or VME64x slots with space to the rear of the backplane for I/O connection. The chassis is not only ideal for use in the development environment, but also for demonstration or target systems. The core of the system is based on the IEEE1101.10/11 compliant KM6-RF subrack, housed in the versatile and stylish DIPLOMAT caseframe, resulting in a system that is compact but still provides easy access. Based around Verotec standard solutions, the chassis may be easily adapted for specific applications.

## THERMAL MANAGEMENT

Cooling is provided by two 120mm ball-bearing DC fans installed on a tray below the cardframe, drawing air from the bottom front, forced up through the card cage, to exhaust at the top rear – cooling the board set and any front pluggable power supplies. When embedded supplies are specified, these have integral cooling fans fitted.

## POWER SUPPLY

The system can be supplied with a range of power supply options, typically using an embedded supply mounted on the rear panel. Alternatively, front pluggable PICMG 2.11 compliant may be fitted. These power factor corrected supplies can be configured as load-sharing or redundant operation for use in high availability applications.

## EMC

Basing the design on the Diplomat enclosure ensures a high level of shielding and with the KM6-RF subrack meeting IEEE 1101.10/11, a high level of EMC integrity is achieved. An ESD bonding point is provided on the front panel to aid in the safe insertion or extraction of boards, while a switched, fused & filtered IEC power inlet controls conducted noise to EN55022 level B.

## BACKPLANE

The chassis is available with a range of backplane options, covering both CPCI and VME64x architectures. The CPCI options include 6U, 6 and 8 slot, 64 bit, PICMG 2.0 R3.0 compliant backplanes with rear plug-up connectors in P3, P4 & P5 and selectable coded I/O voltage (default = 5V). Other options, including CT/H.110 (Computer Telephony) versions or PICMG 2.16 (packet switching) backplanes may be fitted. The VME64x version is a 10 slot ANSI/VITA 1.1 – 1997 compliant backplane fitted with active on-board termination, electronic ABG (auto bus grant) and with centre P0/J0 connectors fitted.

## REDUCED HEIGHT - 3U BACKPLANE VERSIONS

There remains the option to specify a reduced height chassis designed to accommodate a 3U backplane – either in CPCI or VME64x format. In this case, the overall chassis can be reduced with a corresponding reduction in the cardcage height. In this case, if front pluggable power supplies are required, 3U versions are available. For a typical system, please see our VPX TecSYS chassis.

## FEATURES

- Chassis
  - Diplomat desktop enclosure
  - 6U, half width x 422mm
  - Front tilt feet standard
- IEEE 1101.10/11 Cardframe
  - 6U x 40HP x 160mm Front area
  - Full height access to the rear of the backplane for I/O connection
- Backplane
  - 10-slot 6U, VME64x
  - 6 or 8 slot PICMG 2.0 Rev 3.0 CPCI
  - CPCI Selectable coded I/O voltage – default =5V'
- Cooling
  - Two fans 120mm x 120mm x 32mm, 120 CFM
  - Dual ball bearing – long life
- Power Supply
  - Autoranging 110/240 VAC, 50/60 Hz
  - Embedded 700W rear panel
  - PICMG 2.11 compatible 500W (pluggable P47 connector)



D10 – Desktop 10 slot (Half-width) System



Thermal protection



Rear View

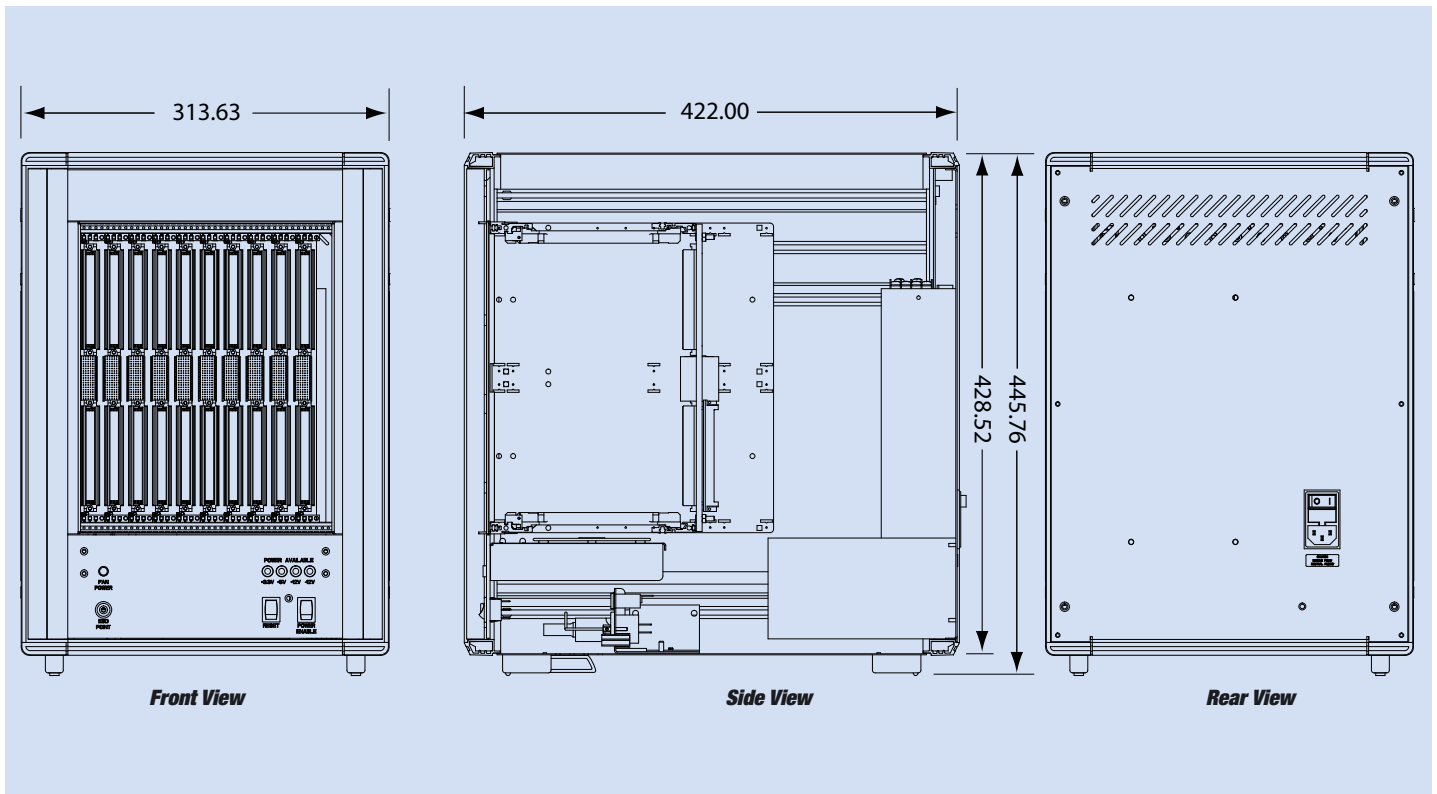

## SPECIFICATION

### Dimensions

Width	313.63mm / 12.35"
Depth	422.00mm / 16.6"
Height	445.76mm / 17.55"

### Material & Finish

Diplomat chassis - Top, bottom, rear & side infill covers –	Steel (Textured electrostatic epoxy finish)
All other parts –	Light Grey BS 4800 00A01
KM6-RF Subrack -	Mid Grey BS4800 00A05
Front infill –	Aluminium alloy (Iridite NCP)
	Aluminium alloy (Anodised)

### Environmental

Operating Temperature	0°C to +50°C
Storage Temperature	-20°C to +80°C

### Power Supply (Typical)

	Pluggable 500W (each)	Embedded 700W
AC Input	90 – 264 V @ 47-63 Hz	90 – 264 V @ 47-63 Hz
Output	+5V @ 65A	+5V @ 60A
	+3.3V @ 80A	+3.3V @ 60A
	+12V @ 12A	+12V @ 10A
	-12V @ 1.5A	-12V @ 8A

## ACCESSORIES

A range of accessories are available including air baffle cards, disk drive mounting adaptors, filler panels and more – please contact sales office for further information



## ORDERING INFORMATION

<b>1</b>	<b>4</b>	<b>1</b>	<b>-</b>	<b>4</b>	<b>2</b>	<b>1</b>	<b>1</b>	<b>X</b>	<b>X</b>	<b>X</b>
POWER – OUTPUT										
500W Pluggable									6	
700W Embedded									8	
BACKPLANE										
VME64x Extensions (With P0)									2	
Standard CompactPCI (PICMG 2.0 R.3)									5	
CPCI + Computer Telephony H110 (PICMG 2.5)									6	
CPCI + Packet Switching (PICMG 2.16)									7	
NUMBER OF SLOTS										
6 Slot										3
8 Slot										4
10 Slot										5
(Note – embedded PSU format only)										

## CUSTOMIZING OPTIONS

The modular, scalable design enables it to be used for developments based on other backplanes. With a wide range of options available, it would be impossible to list every combination. Where the system is to be deployed away from users, a system monitor can be supplied to allow remote monitoring and control. Should your application require a different specification such as backplane, cooling or power supply variants, please contact us to discuss.

## ADDITIONAL NOTES

**Chassis** – The choice of Diplomat is obvious, offering a robust chassis with stylish looks and featuring side carrying handles for easy transit. Tilt feet are fitted, allowing a change of viewing angle on the desktop. The top cover is easily removable - only two screws need to be loosened for access.

**Subrack** - The chassis is fitted with Verotec's KM6-RF subrack offering front panel coding options to ensure correct board insertion to the appropriate slot. In addition ESD protection and pre-location features are present, along with inject/eject functionality and PCB grounding – all designed to protect the daughter boards.

**Front Panel** – Featuring status LED's for each of the voltage rails and also indicates power to the fans as well as an ESD wrist strap bonding point. A reset (momentary) switch is provided for customer defined use.

# D21 – Desktop 21 slot (Full Width) System

## INTRODUCTION

Offered as a 9U, full width desktop system, the D21 system accepts up to 21 vertically mounted 6U x 160mm CPCI or VME64x slots and with an 80mm deep rear transition area as standard. The chassis is not only ideal for use in the development environment, but is also suitable for demonstration or target systems. The core of the system is based on Verotec's IEEE1101.10/11 compliant KM6-RF subrack, housed in the versatile and stylish DIPLOMAT caseframe, resulting in a system that is compact but still provides easy access. The subrack is recessed within the enclosure to optimise cable management off the board fronts. Based around Verotec standard solutions, the chassis may be easily adapted for specific applications with a choice of backplanes and with various power options available. Cooling is provided by a removable fan tray housed behind a 2U vented front panel which also features the status indicators and switches as well as an ESD point.

## THERMAL MANAGEMENT

Effective cooling is provided by a combination of three 120mm fans arranged in a slide-fit removable fan tray mounted directly below the cardframe, drawing air through a filter in the vented panel at the bottom front of the chassis, up through the cards and exhausted to the top-rear. All fans are DC powered from the autoranging power supplies and an even distribution of cooling is achieved by the provision of plenum space above and below the subrack.

## POWER SUPPLY

The user has a wide choice of supplies; where the full backplane width capability is required, there is a choice of embedded power supplies; available as either 700 or 1000W output units mounted in the base of the unit. If the rack is not required to house the full 21 slots capability of boards, front mounted CPCI type pluggable supplies may be considered. Two of these 6U supplies, rated at 500W each, can be used in a power sharing hot-swap mode for high-availability applications

## EMC

Proven practices have been adopted in the design of the chassis. The cards are housed in Verotec's IEEE 1101.10 compliant KM6-RF conductive subrack, and chassis vent patterns have been designed to allow maximum airflow while still maintaining shielding effectiveness. Power is introduced through a filtered IEC inlet (also switched and fused) to minimise conducted noise. An earth bonding point is provided on the front panel for a wrist strap connection to ensure ESD protection when inserting or extracting boards.

## BACKPLANE

Verotec has a comprehensive range of backplanes available, covering a wide range of slot sizes and bus architectures. The chassis shown is fitted with a 10 slot VME64x backplane; however other widths of VME64x or CPCI backplanes may be selected. Verotec offer a comprehensive range of architectures covering VME, VME64x, CompactPCI, PXI, VXS, VXI and VPX – please contact your sales office if you have a special requirement.



D21 Chassis with dual 10 Slot VME64x Backplane



D21 Chassis – Rear View



Hinged, vented & filtered air inlet panel provides access to removable fantray

## FEATURES

- Chassis
  - Up to 21 slots on 4HP of 6U vertical cards
  - 9U, 19" full width x 426mm
  - Recessed card cage for cable management
  - Hinged front blank panel optional
  - Hinged drop down access panel on rear
- IEEE 1101.10/11 Cardframe
  - 6U x 160mm Front card area
  - 6U x 80mm rear transition area
- Backplane
  - 1 to 21 slots
  - CPCI or VME64x backplanes
  - Other backplane options available
- Cooling
  - Three DC fans 120mm x 120mm, each rated at 120 CFM
  - Removable air inlet filter
  - Internal PSU fan for embedded supplies
- Power Supply
  - Autoranging 90-264VAC 50-60 Hz
  - Choice of PSU format
    - 1 or 2 x Modular 500w CPCI 2.11 front pluggable
    - 700 or 1000w embedded
- Front Panel Hardware
  - LED indicators for backplane voltage and fan operation
  - Reset & Power Enable switches

# D2I – Desktop 2I slot (Full Width) System

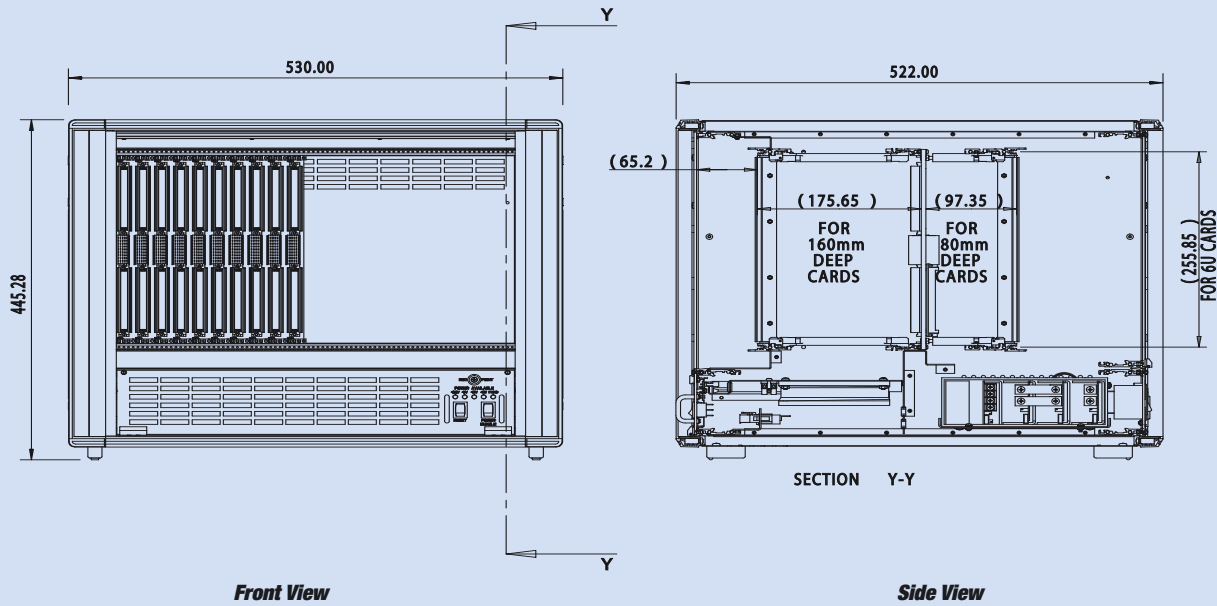

## SPECIFICATION

### Dimensions

Width	530mm / 20.87"
Depth	552mm / 20.55"
Height	445.28mm / 17.53"

### Material & Finish

Diplomat chassis -	Steel (Textured electrostatic epoxy finish)
Top, bottom, rear & side infill covers -	Light Grey BS 4800 00A01
All other parts -	Mid Grey BS4800 00A05
Chassis -	Aluminium alloy (Iridite NCP)
KM6-II Subrack -	Aluminium alloy (Iridite NCP)
Front infill -	Aluminium alloy (Anodised)

### Environmental

Operating Temperature	0°C to +50°C
Storage Temperature	-20°C to +80°C

### Power Supply (Typical)

	Pluggable 500W (each)	Embedded 700W	Embedded 1000W
AC Input	90 – 264 V @ 50-60 Hz	90 – 264 V @ 50-60 Hz	90 – 264 V @ 50-60 Hz
Output	+5V @ 65A	+5V @ 60A	+5V @ 120A
	+3.3V @ 80A	+3.3V @ 60A	+3.3V @ 60A
	+12V @ 12A	+12V @ 10A	+12V @ 10A
	-12V @ 1.5A	-12V @ 8A	-12V @ 8A

## ACCESSORIES

A range of accessories are available including air baffle cards, disk drive mounting adaptors, filler panels and more – please contact sales office for further information

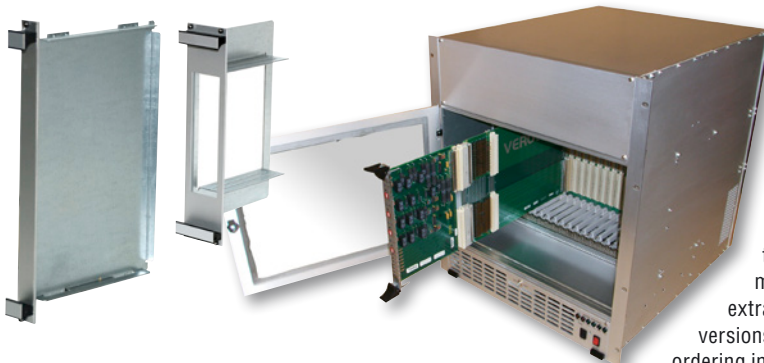

## EXTENDER BOARDS

Available with or without the centre P0 connectors, these 6U x 330mm multilayer extenders are for use in VME64x applications and are designed to bring cards out of a system for fault diagnostic or development work. Jumper links are provided on all signal lines for interrogation and an additional connector is fitted for connection to a logic analyser or termination module. Available separately is a metal frame to support the card and provide extraction functionality by two levers. CompactPCI versions are also available. Please consult the factory for ordering information.

## ORDERING INFORMATION

<b>1</b>	<b>4</b>	<b>1</b>	<b>-</b>	<b>4</b>	<b>4</b>	<b>1</b>	<b>1</b>	<b>X</b>	<b>X</b>	<b>X</b>
<b>POWER - OUTPUT</b>										
Single	500W	pluggable							6	
Double	500W	pluggable							7	
Single	700W	embedded							8	
Single	1000W	embedded							9	
<b>BACKPLANE</b>										
VME64x Extensions (With P0)									2	
Standard CompactPCI (PICMG 2.0 R.3)									5	
CPCI + Computer Telephony H110 (PICMG 2.5)									6	
CPCI + Packet Switching (PICMG 2.16)									7	
<b>NUMBER OF SLOTS</b>										
	8									4
	10									5
	14									7
	17									8
	21									9

## CUSTOMIZING OPTIONS

The scalable design enables options based on other 3U and 6U backplanes across all bus structures such as VMEbus, VME64x and cPCI very easily. Where the system is to be deployed away from users, a system monitor can be supplied to allow remote monitoring and control. With a wide range of options available, it would be impossible to list every combination. Should your application require a different specification such as backplane, cooling or power supply variants, please contact us to discuss.

# V4 – 4U Rackmount – 21 slot System

## INTRODUCTION

For applications based around the popular 3U format board, the V4 system from Verotec offers a highly flexible solution in a condensed package. The chassis is based around the KM6-RF subrack in the industry standard 19" rackmount format. This allows the full 21 slots of 4HP spacing, and is ideally suited to CPCI designs where a combination of boards and power supplies can easily be implemented. Cooling is provided over the full width, the power supplies are pluggable, mating with a chassis mounted power interface board. This means that the user can move the boards and power supplies around to provide, say, two complete 6 or 8 slot systems, each with its own power supply, within one chassis with a choice whether the power supplies are at the ends or in the middle. Dual PSU's for power sharing/redundancy also becomes simple to implement – or even a combination of multiple 4 slot systems, there are a huge range of choices, including the ability to include a caddy mounted Hard Disk Drive. The KM6-RF subrack offers front panel coding to ensure correct board positioning – important with such a flexible system. In addition ESD protection and pre-location features are present, along with inject/eject functionality and PCB grounding – all designed to protect the daughter boards.

## THERMAL MANAGEMENT

Special attention was paid to thermal design, with the need to ensure cooling for all possible combinations – so low-profile fans were specified, to allow for a plenum space both above and below the fans, housed in the 1U cavity beneath the cardcage. This allows the fans to draw from below, through a vented pattern, and provide cooling to every position across the 21 slots. The airflow is vertical, exiting through a corresponding vent pattern in the top cover - it is therefore possible to place two such systems in a rack directly on top of each other. The fans are DC powered, derived from the autoranging power supply.

## POWER SUPPLY

Power supply choice allows for either 200W or 300W modules, which may be supplied either from AC or DC sources. These PSU's may be independent for each backplane or used together or in combinations to provide power sharing or hot-swap/redundant operation for high availability systems. The supplies also have been chosen for having two separate converters – rated current can be drawn from the +5V and 3V3 outputs simultaneously.

## EMC

Chassis design adopts best practice for EMC – the card cage is conductive (an Iridite finish), fully compliant with IEEE 1101.10 it offers a first-mate ESD pin capability and PCB grounding in the cardguide. Boards with corresponding front panels then provide an EMC seal along their edges, ensuring a complete 'cage'. Vent patterns have kept the overall aperture area large to maintain airflow, but with small geometries to ensure a lower frequency cut-off. With AC supplies, a filtered IEC (also switched and fused) at the rear minimises conducted noise.

## BACKPLANE

Verotec offer a wide range of backplanes – the V4 is ideal for CPCI applications or VME J1 backplanes. The standard CPCI offerings are three widths of backplane, covering 4, 6, or 8 slots. These are available either as the 32bit backplane with rear I/O pins, or for the fully bussed 64bit - please contact your sales office if you have a special requirement.

## HARD DISK DRIVE CADDY 2.5"

Verotec offer a Hard Disk Drive Caddy – this adapter is designed to comply with the industry standard IEC60297 for Eurocard applications, providing a convenient way of including drives into your system.



Hard Disk Drive Caddy 2.5" – 4HP



V4 – 4U Rackmount full-width system



3U x 160mm 84HP / 21 slot capability

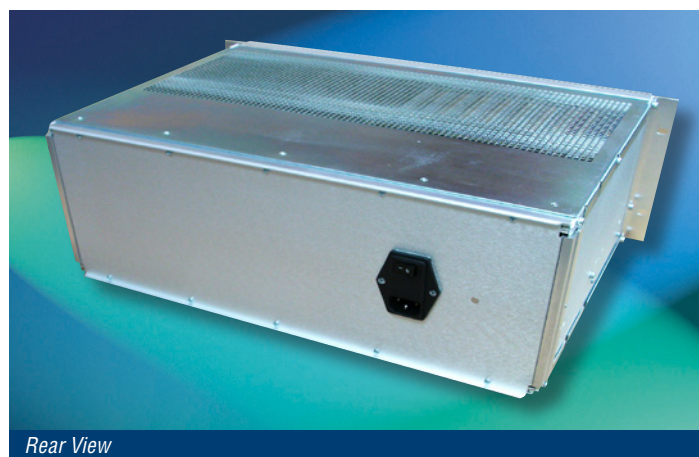

Rear View

## FEATURES

- Chassis
  - Up to 21 slots on 4HP of 3U vertical cards
  - 4U, 19" full width x 309mm rear depth
  - Accepts 2.5" HDD Caddy
- IEEE 1101.10/11 Cardframe
  - 3U x 160mm Front card area
  - Front panel coding & pre-location
  - Inject/eject capability
- Backplane
  - 1 to 21 slots equivalent
  - CPCI Backplanes
    - 32 bit with rear I/O connectors
    - 64 bit bussed
    - Default VI/O set at 5v (reconfigurable)
- Cooling
  - Three low-profile 86CFM DC fans 120mm x 120mm
  - Dual ball bearing – long life
- Wide range of PSU options
  - Autoranging 90-264VAC 50-60 Hz
  - Single or dual pluggable supplies
  - AC or DC input options
  - Hot swap / redundancy capability
  - Switched, fused & filtered IEC inlet

Description	Ordercode
Hard Disk Drive Caddy 2.5" – 4HP	950-4002633

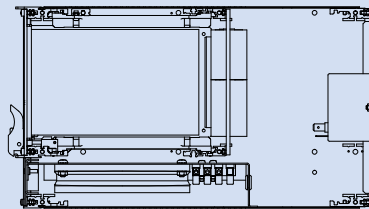
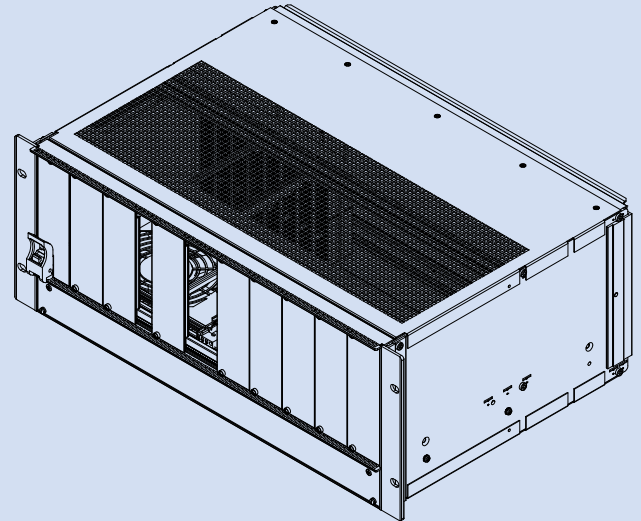
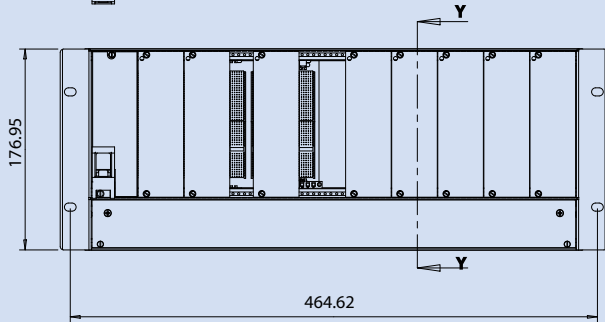
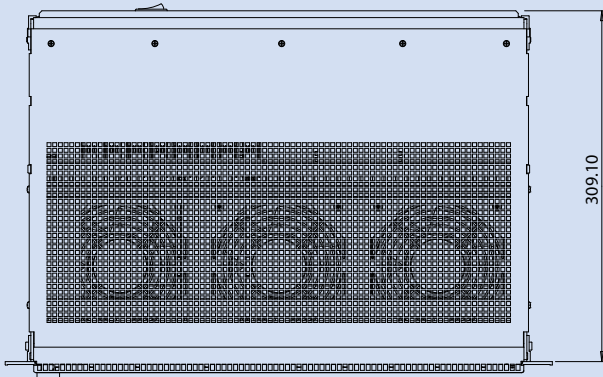
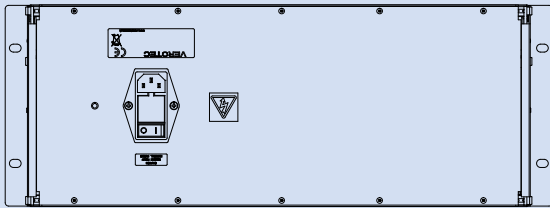

SECTION Y-Y

## SPECIFICATION

### Dimensions

Width	482.60mm / 19"
Depth	309.1mm / 12.2"
Height	176.95 mm / 6.96" (4U)

### Material & Finish

Chassis -	Aluminium alloy (Iridite NCP)
KM6-II Subrack -	Aluminium alloy (Iridite NCP)
Front & rear infill -	Aluminium alloy (Anodised)

### Environmental

Operating Temperature	0°C to +50°C
Storage Temperature	-20°C to +80°C

### Power Supply

	Pluggable 200W (each)	Pluggable 300W (each)
AC Input	90 – 264 V @ 50-60 Hz	90 – 264 V @ 50-60 Hz
DC Input	18-36V DC	18-36V DC
Output	+5V @ 25A	+5V @ 30A
	+3.3V @ 36A	+3.3V @ 40A
	+12V @ 5A	+12V @ 5A
	-12V @ 0.5A	-12V @ 1A

## BLANKING PANELS

Please Note – Blanking Panels must be ordered separately for this system, none are provided as standard.

Description: Shielded 3U Front Panel	Order Code
4HP	951 - 4004079
6HP	951 - 4004081
8HP	951 - 4004082

Other sizes and styles are available – from 2HP to 84 HP – please consult your sales office

## ORDERING INFORMATION

<b>1</b>	<b>4</b>	<b>1</b>	<b>-</b>	<b>3</b>	<b>2</b>	<b>1</b>	<b>X</b>	<b>X</b>	<b>X</b>	<b>X</b>
POWER - INPUT							1			
AC Operation							2			
DC Operation (24V)										
POWER - OUTPUT							2			
Single 200W pluggable							3			
Double 200W pluggable							4			
Single 300W pluggable							5			
Double 300W pluggable										
BACKPLANE							3			
3U CompactPCI (PICMG 2.0 R.3)32bit with I/O							4			
3U CompactPCI (PICMG 2.0 R.3)64 bit										
NUMBER OF SLOTS							1			
4							3			
6							4			
8										

## CUSTOMIZING OPTIONS

Please Note – With a wide range of options available, it would be impossible to list every combination. Should your application require a different specification such as backplane, cooling or power supply variants, please contact us to discuss.

# V8 – 8U Rackmount – 21 slot System

## INTRODUCTION

For rackmount applications that need to accommodate up to the maximum 21 slots of 6U x 4HP card space available within the 19" rack format, the Verotec V8 chassis provides an ideal solution in a compact 8U enclosure. Based around our KM6-II Eurocard subrack, the system can be specified with a range of power supply and backplane options. Cooling is provided by a removable fan tray housed behind a hinged 2U front panel. This panel is vented for cooling and also features the status indicators and switches as well as an ESD point. The power supply is an embedded type, mounted on the rear drop down panel. A separate 3U rear panel allows access for cable management or to house additional components. With the total 84HP available, this system can take the full range of VME backplanes – from 5 to 21 slots and of course Verotec also offers a wide range of other bus architectures and slot options.

## THERMAL MANAGEMENT

Effective cooling is provided by a combination of three 120mm fans arranged in a removable fan tray mounted directly below the cardframe, drawing air through a filtered and vented panel at the bottom front of the chassis, up through the cards and exhausted through a vented top cover. When powered by an embedded PSU attached to the rear panel, the supply is directly cooled by its own internal fan, venting from side-to-side. All fans are DC powered from the autoranging power supplies and are capable of providing sufficient airflow to dissipate the large amount of heat generated by the latest CPU boards.

## POWER SUPPLY

There is a choice of rear mounted power supplies; available as either 700 or 1000W output units, mounted on a 5U hinged rear panel, offering easy access to the PSU and to the rear of the backplane.

## EMC

Proven practices have been adopted in the design of the chassis. The cards are housed in Verotec's IEC 60297-3 compliant KM6-II conductive subrack, and chassis vent patterns have been designed to allow maximum airflow while still maintaining shielding effectiveness. An earth bonding point is provided on the front panel for a wrist strap connection to ensure ESD protection when inserting or extracting boards.

## BACKPLANE

V8 chassis incorporate a 6U Monolithic (J1/J2) VME backplane, compliant to the ANSI/IEEE Std 1014-1987 specification. All backplanes have on-board passive termination, auto bus-granting connectors and power bug / busbar power connections. Verotec offer a comprehensive range of backplane architectures – please contact your sales office if you have a special requirement.

## CUSTOMIZING OPTIONS

The scalable design enables options based on other 3U and 6U backplanes across all bus structures such as VMEbus, VME64x and cPCI very easily. Where the system is to be deployed away from users, a system monitor can be supplied to allow remote monitoring and control. With a wide range of options available, it would be impossible to list every combination. Should your application require a different specification such as backplane, cooling or power supply variants, please contact us to discuss.



V8-8U Rackmount – 21 slot System (12 slot VME shown)

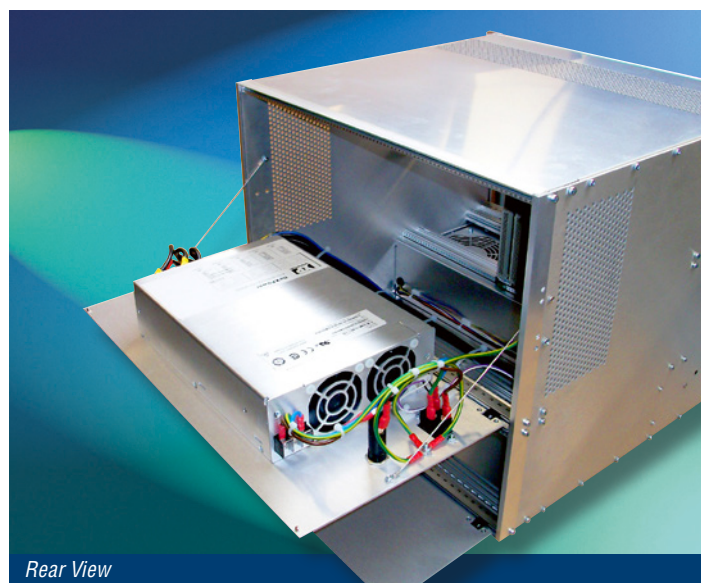

Rear View

## FEATURES

- Chassis
  - Up to 21 slots on 4HP of 6U vertical cards
  - 8U, 19" full width x 426mm
  - Hinged drop down access panels front and rear
- IEC 60297-3 Cardframe
  - 6U x 160mm Front card area
- Backplane
  - 5 to 21 slots – with Auto Bus Grant connectors & On-board termination
  - 6U J1/J2 VME (ANSI/IEEE Std 1014-1987)
- Cooling
  - Three DC fans 120mm x 120mm, each rated at 120 CFM
  - Dual ball bearing – long life
  - Internal PSU fan for embedded supplies
  - Removable, filtered air inlet
- Power Supply
  - Autoranging 90-264VAC 50-60 Hz
  - 700 or 1000w embedded, mounted on rear panel
- Front Panel Hardware
  - LED indicators for backplane voltage and fan operation
  - Reset & Power Enable switches
  - ESD wrist strap point



# V8 – 8U Rackmount – 21 slot System

## SPECIFICATION

### Dimensions

Width	482.22mm / 19"
Depth	426.3mm / 16.8"
Height	354.75mm / 13.96" (8U)

### Material & Finish

Chassis -	Aluminium alloy (Anodised)
KM6-II Subrack -	Aluminium alloy (Iridite NCP)
Front & rear infill -	Aluminium alloy (Anodised)

### Environmental

Operating Temperature	0°C to +50°C
Storage Temperature	-20°C to +80°C

### Power Supply (Typical)

	Embedded 750W	Embedded 1000W
AC Input	90 – 264 V @ 50-60 Hz	90 – 264 V @ 50-60 Hz
Output	750W	1000W
+5V @ 120A		150A
+12V @ 12/20A pk		20/30A pk
-12V @ 10A		10A
+12V @ 5A		10A

## ORDERING INFORMATION

<b>1 4 1 - 3 4 1 1 X 1 X</b>	
POWER - OUTPUT	
Single 700W embedded	8
Single 1000W embedded	9
NUMBER OF SLOTS	
5	2
10	5
12	6
17	8
21	9

## AIR BAFFLE CARDS

The air baffle card is designed to be used in vacant system slots to both close the front panel area and block airflow. In doing so, cooling air is diverted to active cards, thus maintaining the correct system airflow profile.



## ORDERING INFORMATION

Standard (IEC 60297) versions:

Description	Ordercode
6U x 160mm, with handles	950-4001333
6U x 160mm, without handles	950-4001334

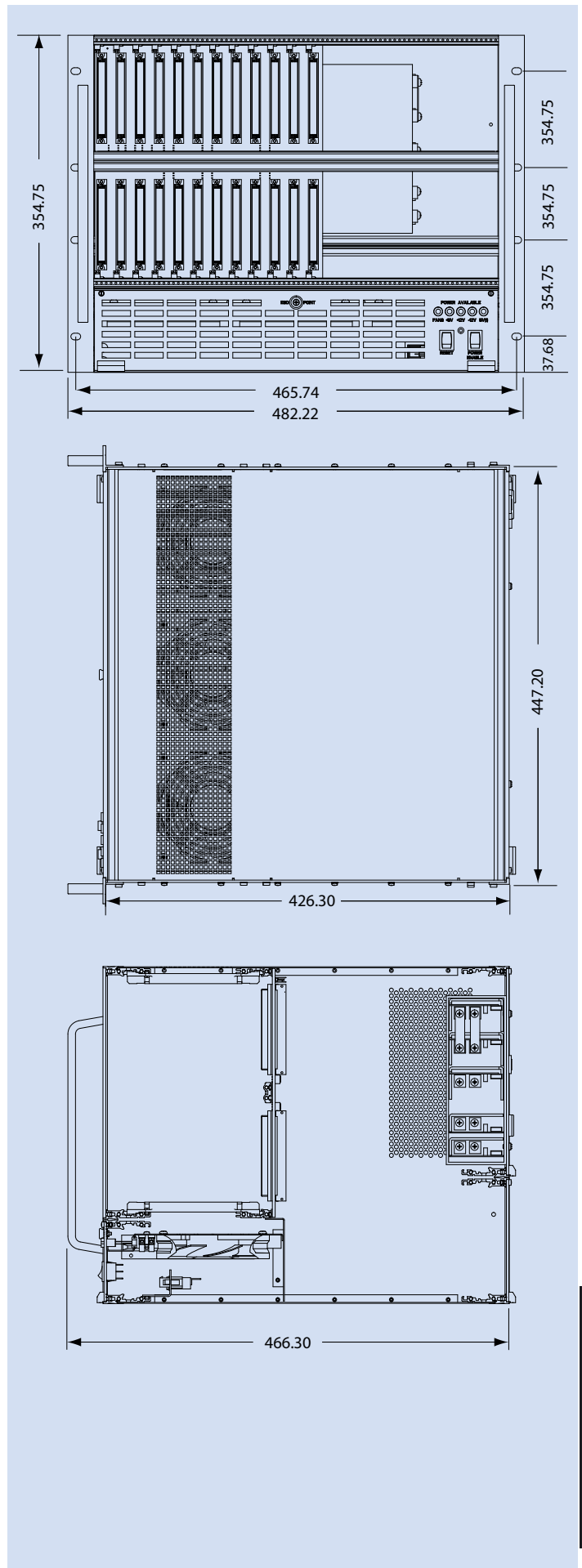

# V9 – 9U Rackmount – 21 slot System

## INTRODUCTION

The V9 chassis may be used either in rackmount applications, or alternatively as a stand-alone unit in the Diplomat enclosure. Offering the full width 19" chassis allows for the full 21 slots of 4HP cards, typically in VME64x or CPCI architecture systems. Cards are mounted in the KM6-RF subrack, recessed back to allow for front cable management. The subrack is fully IEEE 1101.10/11 compliant, with provision for rear transition modules to be accommodated. As an option, the front may be closed off with a hinged blank panel. In addition to a choice of backplanes, various power options are available – either embedded in the base of the unit, or as pluggable modules where the full 21 slots are not required. Cooling is provided by a removable fan tray housed behind a 2U front panel. This panel is vented for cooling and also features the status indicators and switches as well as an ESD point.

## THERMAL MANAGEMENT

Effective cooling is provided by a combination of three 120mm fans arranged in a removable fan tray mounted directly below the cardframe, drawing air through a filtered and vented panel at the bottom front of the chassis, up through the cards and exhausted to the top-rear. All fans are DC powered from the autoranging power supplies and are capable of providing sufficient airflow to dissipate the large amount of heat generated by the latest CPU boards.

## POWER SUPPLY

The user has a wide choice of supplies; if the rack is not required to house the full 21 slots capability of boards, front mounted CPCI pluggable supplies may be considered. Two of these 6U supplies, rated at 500W each, can be used in a power sharing hot-swap mode for high-availability applications. Where the full backplane width capability is required, there is again a choice of embedded power supplies; available as either 700 or 1000W output units.

## EMC

Proven practices have been adopted in the design of the chassis. The cards are housed in Verotec's IEEE 1101.10 compliant KM6-RF conductive subrack, and chassis vent patterns have been designed to allow maximum airflow while still maintaining shielding effectiveness. Power is introduced through a filtered IEC inlet (also switched and fused) to minimise conducted noise. An earth bonding point is provided on the front panel for a wrist strap connection to ensure ESD protection when inserting or extracting boards.

## BACKPLANE

Verotec has a comprehensive range of backplanes available, covering a wide range of slot sizes and bus architectures. The chassis shown is fitted with a 10 slot VME64x backplane; however other widths of VME64x or CPCI backplanes may be selected. Verotec offer a comprehensive range of architectures covering VME, VME64x, CompactPCI, PXI, VXS, VXI and VPX – please contact your sales office if you have a special requirement.



V9 Chassis with 10 Slot VME64x Backplane

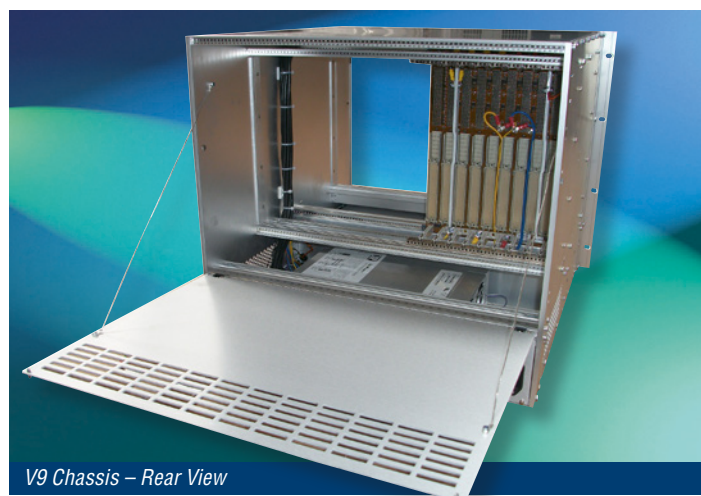

V9 Chassis – Rear View

## FEATURES

- Chassis
  - Up to 21 slots on 4HP or 6U vertical cards
  - 9U, 19" full width x 426mm
  - Recessed card cage for cable management
  - Front close-off available
  - Hinged drop down access panel on rear
- IEEE 1101.10/11 Cardframe
  - 6U x 160mm Front card area
  - 6U x 80mm rear transition area
- Backplane
  - 1 to 21 slots
  - CPCI or VME64x backplanes
  - Other backplane options available
- Cooling
  - Three DC fans 120mm x 120mm, each rated at 120 CFM
  - Removable air inlet filter
  - Internal PSU fan for embedded supplies
- Power Supply
  - Autoranging 90-264VAC 50-60 Hz
  - Choice of PSU format
    - 1 or 2 x Modular 500w CPCI 2.11 front pluggable
    - 700 or 1000w embedded
- Front Panel Hardware
  - LED indicators for backplane voltage and fan operation
  - Reset & Power Enable switches
  - ESD wrist strap point



Hinged, vented & filtered air inlet panel provides access to removable fantray

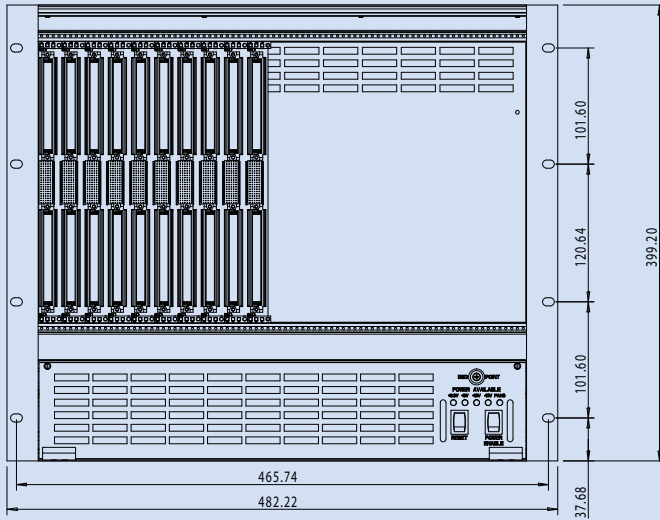

**V9 Chassis - Front View**

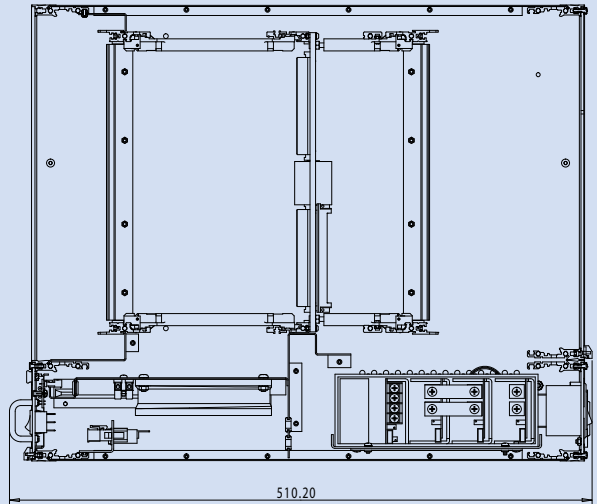

**V9 Chassis - Side View**

## SPECIFICATION

### Dimensions

Width	482.22mm / 19"
Depth	488mm / 19.2"
Height	399.2mm / 15.7"

### Material & Finish

Chassis -	Aluminium alloy (Iridite NCP)
KM6-II Subrack -	Aluminium alloy (Iridite NCP)
Front & rear infill -	Aluminium alloy (Anodised)

### Environmental

Operating Temperature	0°C to +50°C
Storage Temperature	-20°C to +80°C

### Power Supply (Typical)

	Pluggable 500W (each)	Embedded 700W	Embedded 1000W
AC Input	90 - 264 V @ 50-60 Hz	90 - 264 V @ 50-60 Hz	90 - 264 V @ 50-60 Hz
Output	+5V @ 65A	+5V @ 60A	+5V @ 120A
	+3.3V @ 80A	+3.3V @ 60A	+3.3V @ 60A
	+12V @ 12A	+12V @ 10A	+12V @ 10A
	-12V @ 1.5A	-12V @ 8A	-12V @ 8A

## ACCESSORIES

A range of accessories are available including air baffle cards, disk drive mounting adaptors, filler panels and more - please contact sales office for further information

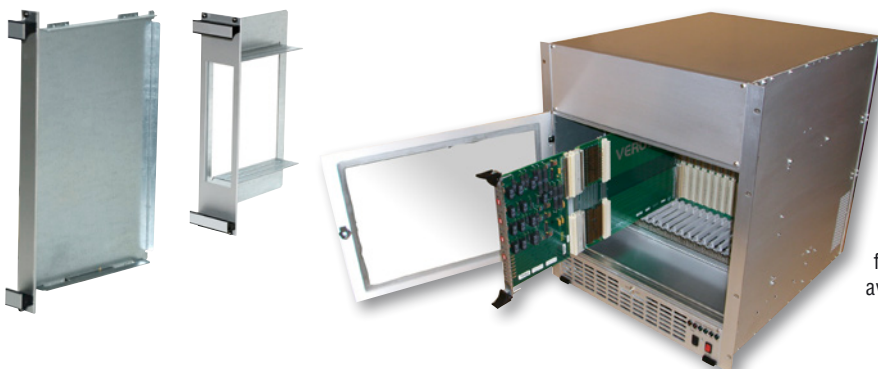

## ORDERING INFORMATION

<b>1</b>	<b>4</b>	<b>1</b>	<b>-</b>	<b>3</b>	<b>6</b>	<b>1</b>	<b>1</b>	<b>X</b>	<b>X</b>	<b>X</b>
<b>POWER - OUTPUT</b>										
Single	500W pluggable							6		
Double	500W pluggable							7		
Single	700W embedded							8		
Single	1000W embedded							9		
<b>BACKPLANE</b>										
	VME64x Extensions (With P0)								2	
	Standard CompactPCI (PICMG 2.0 R.3)								5	
	CPCI + Computer Telephony H110 (PICMG 2.5)								6	
	CPCI + Packet Switching (PICMG 2.16)								7	
<b>NUMBER OF SLOTS</b>										
	8									4
	10									5
	14									7
	17									8
	21									9

## CUSTOMIZING OPTIONS

The scalable design enables options based on other 3U and 6U backplanes across all bus structures such as VMEbus, VME64x and cPCI very easily. Where the system is to be deployed away from users, a system monitor can be supplied to allow remote monitoring and control. With a wide range of options available, it would be impossible to list every combination. Should your application require a different specification such as backplane, cooling or power supply variants, please contact us to discuss.

## EXTENDER BOARDS

Available with or without the centre P0 connectors, these 6U x 330mm multilayer extenders are for use in VME64x applications and are designed to bring cards out of a system for fault diagnostic or development work. Jumper links are provided on all signal lines for interrogation and an additional connector is fitted for connection to a logic analyser or termination module. Available separately is a metal frame to support the card and provide extraction functionality by two levers. CompactPCI versions are also available. Please consult the factory for ordering information.

# V12 - 12U Rackmount - 21 slot System

## INTRODUCTION

Designed for demanding top-end applications, the Verotec 12U System supports the full 21 slots available in the 19" rackmount capability. At the heart of the chassis is the IEEE 1101.10/11 compliant Verotec KM6-RF cardframe, recessed inside the chassis, behind a hinged door with an acrylic window. The system can be specified with a wide range of backplane and power supply options. Effective cooling is provided by a removable fan tray beneath the cardframe, drawing air through a vented panel and also a bank of fans on a hinged panel at the rear of the chassis. This arrangement draws air from the bottom front and exhausts to the top rear - minimising any chance of drawing warmed air back into the system. Power supplies are typically embedded, mounted on a drop-down rear panel for easy access or alternatively PICMG 2.11 front pluggable Eurocard format configurations are available. Standard features include voltage and fan LED's, system reset and an on/off switch all located on the front panel, as well as an ESD point. A separate 3U rear panel allows access for cable management or to house additional components. With the total 84HP available, this system can take the full range of VME backplanes - from 5 to 21 slots and of course Verotec also offers a wide range of other bus architectures and slot options.

## THERMAL MANAGEMENT

The system cooling is provided by a combination of three 120mm fans arranged on a removable fan tray positioned directly below the cardframe, drawing air through a filtered and vented 2U panel at the bottom front of the chassis. A further three similar fans are mounted on a hinged 3U panel at the top of the rear side. This arrangement allows the system to be used in applications with other chassis placed directly above and below the system. When powered by an embedded PSU attached to the rear panel, the supply is directly cooled by its own internal fan, venting from side-to-side. All fans are DC powered from the autoranging power supplies and are capable of providing sufficient airflow to dissipate the large amount of heat generated by the latest CPU boards.

## POWER SUPPLY

The user has a wide choice of supplies; if the rack is not required to house the full 21 slots capability of boards, front mounted CPCI pluggable supplies may be considered. Two of these 6U supplies, rated at 500W each, can be used in a power sharing hot-swap mode for high availability applications. Where the full backplane width capability is required, there is again a choice of rear mounted power supplies; available as either 700 or 1000W output units, mounted on a 5U hinged rear panel, offering easy access to the PSU and to the rear of the backplane.

## EMC

Proven practices have been adopted in the design of the chassis. The cards are housed in Verotec's IEEE 1101.10/11 compliant KM6-RF conductive subrack, and chassis vent patterns have been designed to allow maximum airflow while still maintaining shielding effectiveness. An earth bonding point is provided on the front panel for a wrist strap connection to ensure ESD protection when inserting or extracting boards.

## BACKPLANE

Verotec has a comprehensive range of backplanes available, covering a wide range of slot sizes and bus architectures. The chassis shown is fitted with a 21 slot VME64x backplane; however other widths of VME64x or CPCI backplanes may be selected. Verotec offer a comprehensive range of architectures covering VME, VME64x, CompactPCI, PXI, VXS, VXI and VPX - please contact your sales office if you have a special requirement.

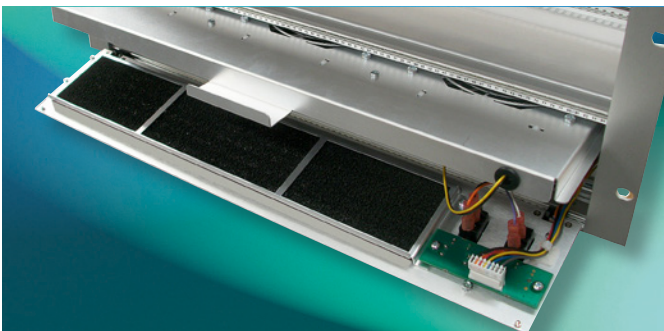

Hinged, vented & filtered air inlet panel provides access to removable fantray



V12 - 12U Rackmount - 21 slot System

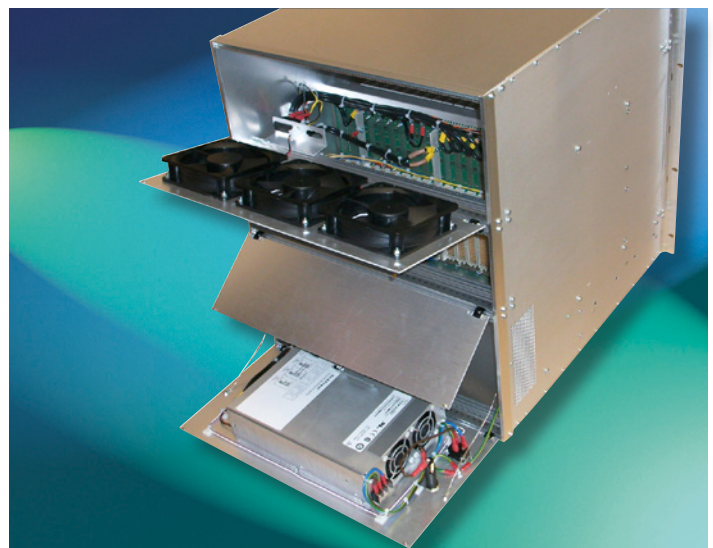

Hinged & vented air inlet panel provides access to removable filter and fantray

## FEATURES

- Chassis
  - Up to 21 slots on 4HP of 6U vertical cards
  - 12U, 19" full width x 553mm
  - Hinged drop down access panels front and rear
- IEEE 1101.10/11 Cardframe
  - 6U x 160mm Front card area
  - Recessed card cage - front cable management
- Backplane
  - 5 to 21 slots
  - CPCI or VME64x backplanes
  - CPCI Backplanes - Selectable coded I/O voltage (default = 5V)
- Cooling
  - Six DC fans 120mm x 120mm, each rated at 120 CFM
  - Dual ball bearing - long life
  - Hinged air inlet with removable filter
  - Internal PSU fan for embedded supplies
- Power Supply
  - Autoranging 90-264VAC 50-60 Hz
  - Choice of PSU format
    - 1 or 2 x Modular 500W CPCI front pluggable
    - 700 or 1000W embedded, mounted on rear panel
- Front Panel Hardware
  - LED indicators for backplane voltage and fan operation
  - Reset & Power Enable switches
  - ESD wrist strap point

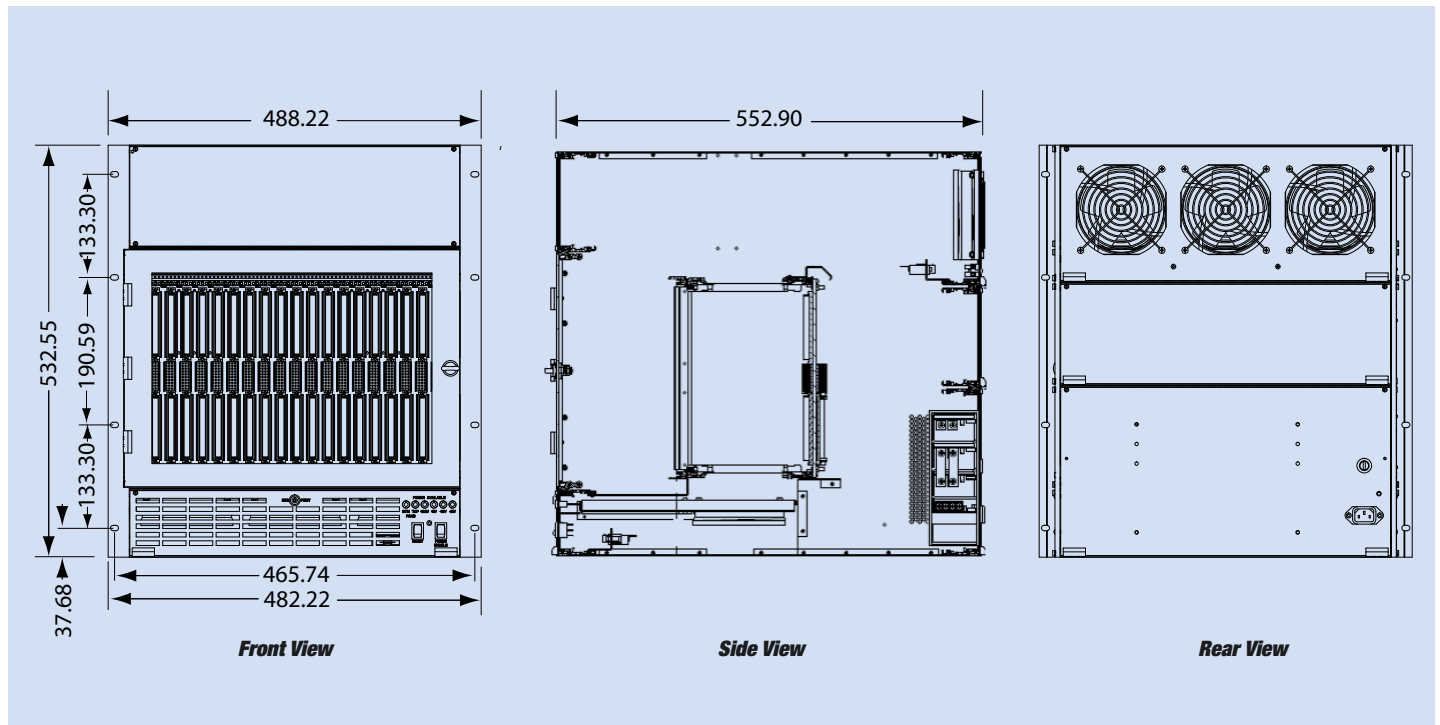

## SPECIFICATION

### Dimensions

Width	482.22mm / 19"
Depth	552.9mm / 21.77"
Height	532.55mm / 20.97" (12U)

### Material & Finish

Chassis -	Aluminium alloy (Iridite NCP)
KM6-RF Subrack -	Aluminium alloy (Iridite NCP)
Front & rear infill -	Aluminium alloy (Anodised)

### Environmental

Operating Temperature	0°C to +50°C
Storage Temperature	-20°C to +80°C

### Power Supply (Typical)

	Pluggable 500W (each)	Embedded 700W	Embedded 1000W
AC Input	90 - 264 V @ 50-60 Hz	90 - 264 V @ 50-60 Hz	90 - 264 V @ 50-60 Hz
Output	+5V @ 65A +3.3V @ 80A +12V @ 12A -12V @ 1.5A	+5V @ 60A +3.3V @ 60A +12V @ 10A -12V @ 8A	+5V @ 120A +3.3V @ 60A +12V @ 10A -12V @ 8A

## ACCESSORIES

A range of accessories are available including air baffle cards, disk drive mounting adaptors, filler panels and more – please contact sales office for further information



## ORDERING INFORMATION

<b>1</b>	<b>4</b>	<b>1</b>	<b>-</b>	<b>3</b>	<b>8</b>	<b>1</b>	<b>1</b>	<b>X</b>	<b>X</b>	<b>X</b>	
POWER - OUTPUT											
Single	500W	pluggable							6		
Double	500W	pluggable							7		
Single	700W	embedded							8		
Single	1000W	embedded							9		
BACKPLANE											
VME64x Extensions (With P0)									2		
Standard CompactPCI (PICMG 2.0 R.3)									5		
NUMBER OF SLOTS											
8 - (max slot count for CPCI backplane)											4
10											5
14											7
17											8
21											9

## CUSTOMIZING OPTIONS

The scalable design enables options based on other 3U and 6U backplanes across all bus structures such as VMEbus, VME64x and cPCI very easily. Where the system is to be deployed away from users, a system monitor can be supplied to allow remote monitoring and control. With a wide range of options available, it would be impossible to list every combination. Should your application require a different specification such as backplane, cooling or power supply variants, please contact us to discuss.

## EXTENDER BOARDS

Available with or without the centre P0 connectors, these 6U x 330mm multilayer extenders are for use in VME64x applications and are designed to bring cards out of a system for fault diagnostic or development work. Jumper links are provided on all signal lines for interrogation and an additional connector is fitted for connection to a logic analyser or termination module. Available separately is a metal frame to support the card and provide extraction functionality by two levers. CompactPCI versions are also available. Please consult the factory for ordering information.

## INTRODUCTION

The VPX specification offers a whole new level of performance. However with no legacy systems around, developers needed a platform to start working from. The TecSYS offers a flexible entry-level solution, with a 5 slot 3U full mesh X4 PCI Express VITA 46.4 backplane in the versatile Diplomat enclosure. The TecSYS chassis is suitable for use in the development environment and for demonstration or target systems. Based around Verotec standard solutions, the chassis may be easily adapted for specific solutions.

## THERMAL MANAGEMENT

Cooling is provided by two 120mm ball-bearing DC fans installed on a tray below the cardframe, drawing air from the bottom front, through the card cage and PSU, to exhaust at the top rear. A pressurised plenum ensures cooling to the main card area, the transition area and to the PSU. Effective cooling is still provided even with the top cover removed or with the rear transition area exposed.

## POWER SUPPLY

The system is fitted with an auto-ranging 300W power supply with active power factor correction. The module is a pluggable type, featuring two separate converters; this allows the supply to provide 5V at 30A and 3.3V at 40A simultaneously.

## EMC

Basing the design on the Diplomat enclosure ensures a high level of shielding and with the KM6-RFsubrack meeting IEEE 1101.10/11, a high level of EMC integrity is achieved. An ESD bonding point is provided on the front panel to aid in the safe insertion or extraction of boards, while a switched, fused & filtered IEC power inlet controls conducted noise to EN55022 level B.

## BACKPLANE

Fitted with a 5 slot VITA 46.0 compliant backplane, configured with a VITA 46.4 Full mesh X4 PCI Express topology interconnect, removing the need for a dedicated switch.

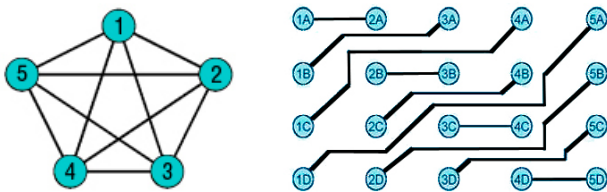

Slot spacing is on 5HP (25.4mm) allowing other VPX permitted widths of daughter board to be accommodated. System management interfaces (I<sup>2</sup>C) are also provided to the user, as well as a JTAG access connector on slot1.

## FEATURES

- **Chassis**
  - Diplomat desktop enclosure with tilt feet
  - 6U, half width x 322mm
- **IEEE 1101.10/11 Cardframe**
  - 3U x 25HP x 160mm Front area
  - 3U x 25HP x 80mm Rear transition area
- **Backplane**
  - 5-slot 3U, compliant to VITA 46.0 baseline specification
  - Supports VITA 46.4 Full Mesh X4 PCI Express-
  - Supports VITA 46.10 with RTM connectors
  - 5HP pitch slot to slot (25.4mm)
  - System management and JTAG access on backplane
- **Cooling**
  - Two fans 120mm x 120mm x 32mm, 120 CFM
  - Dual ball bearing – long life
- **Power Supply**
  - PICMG 2.11 compatible (pluggable P47 connector)
  - 300W auto-ranging (90 – 264VAC)
  - Other power options available



3U VPX 5 slot TecSYS Chassis



Top Cover Removed



Rear View

## SPECIFICATION

### Dimensions

Width	313.84mm / 12.35"
Depth	322.00mm / 12.7"
Height	311.93mm / 12.3"

Weight 10.5Kg / 23.15lbs

### Material & Finish

Diplomat chassis - Top, bottom & side infill covers -	Steel (Textured electrostatic epoxy finish)
Light Grey BS 4800 00A01	
All other parts -	Mid Grey BS4800 00A05
KM6-RF Subrack -	Aluminium alloy (Iridite NCP)
Front Panels, front & rear infill -	Aluminium alloy (Anodised)

### Environmental

Operating Temperature	-5°C to +55°C
Storage Temperature	-30°C to +85°C

### Power Supply

AC Input	90 – 264 VAC @ 50-60 Hz
Output	+5V @ 30A
	+3.3V @ 40A
	+12V @ 5A
	-12V @ 1A
	Total output power = 300W

## ORDERING INFORMATION

Description	Part Number
3U VPX 5 slot TecSYS Chassis	141-1111482

## CUSTOMIZING OPTIONS

The TecSYS modular, scalable design enables it to be used for developments based on other 3U and 6U VPX backplanes as well as other bus structures such as VMEbus, VME64x and cPCI very easily. For increased power, an additional PSU may be fitted, offering power sharing or hot-swap capability. Where the system is to be deployed away from users, a system monitor can be supplied to allow remote monitoring and control.

## ADDITIONAL NOTES

**Chassis** – The choice of Diplomat is obvious, offering a robust chassis with stylish looks and featuring side carrying handles for easy transit. Tilt feet are fitted, allowing a change of viewing angle on the desktop. The top cover is easily removable - only two screws need to be loosened for access.

**Subrack** - The chassis is fitted with Verotec's KM6-RF subrack offering front panel coding options to ensure correct board insertion to the appropriate slot. In addition ESD protection and pre-location features are present, along with inject/eject functionality and PCB grounding – all designed to protect the daughter boards.

**Front Panel** – Featuring status LED's for each of the voltage rails and also indicates power to the fans. A reset (momentary) switch is provided below the ESD wrist strap bonding point for customer defined use. The panel is vented, with additional air also drawn from the bottom face of the chassis and the vent detail features an offset pattern, optimised to maintain EMC shielding.

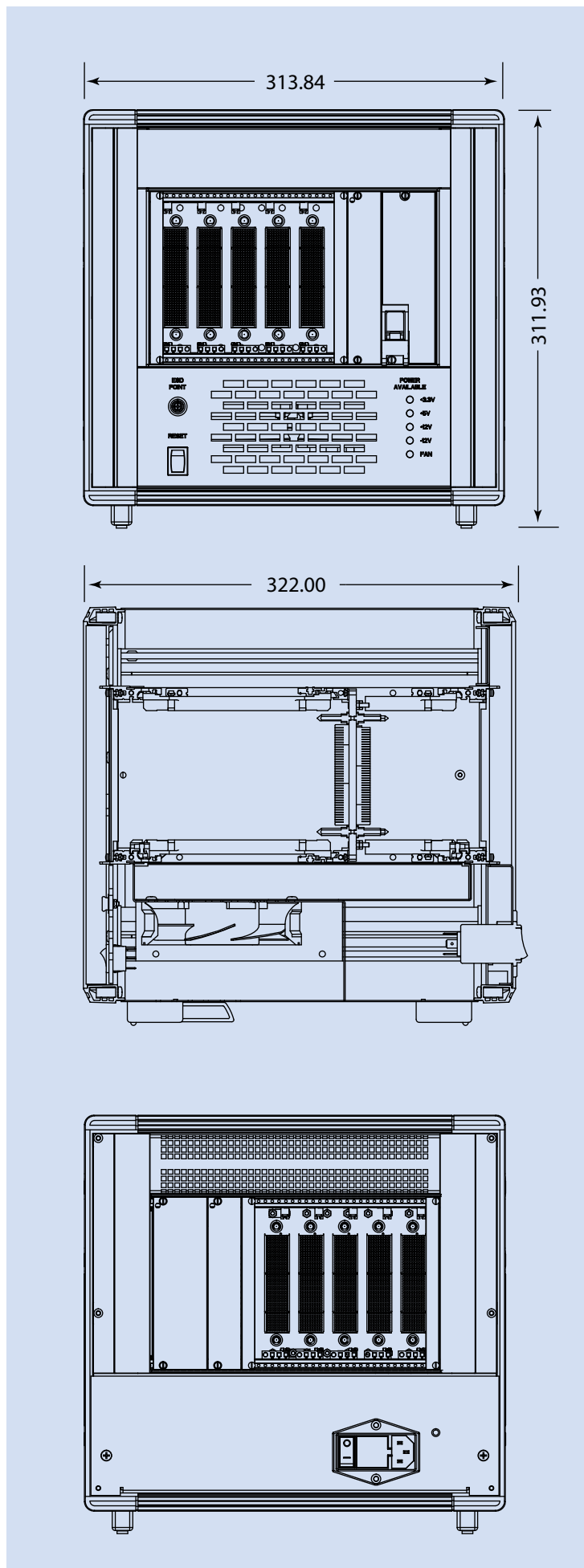

# A6R – 6U 19" Rackmount ATCA Chassis

## INTRODUCTION

The A6R chassis is a 6U, 6 slot, 19" rack mounting ATCA shelf that is powerful and highly configurable, making it suitable for both development and deployed applications. It's versatile and scalable design in terms of system management, cooling, power and backplane topology means it can be used for anything from a simple laboratory / test unit to a high-availability / mission critical system.

The various components of the system are easily selected from a product configurator which produces a unique part number against which the item should be ordered. ATCA chassis' are fully assembled, configured (in terms of hardware, firmware and software) and then fully tested before shipping along with a specific configuration / operating manual. Accessories include filler panels, hot-swap power supplies, fan trays & shelf managers.

## CONCERNING ATCA

ATCA stands for "Advanced Telecommunications Computing Architecture" and is defined under PICMG 3.x. It is designed to offer high bandwidths as well as improved reliability, availability and serviceability. Although originally designed for next generation "carrier" grade communications equipment, it is often considered in other markets & applications such as military, medical & scientific.

## MECHANICS

Unlike VME and CPCI, the Eurocard form factor is not adopted in ATCA; instead, cards (or "blades") are 280mm deep and 322mm high to allow higher component counts and hence more processing power on each card. The chassis itself is referred to as a "shelf" and can be either 19" or ETSI rack mount.

## SYSTEM MANAGEMENT

A big advantage ATCA has over other platforms is its system management functionality which is controlled by the shelf manager. System components such as fan trays, power supplies and power entry modules are collectively known as "Field Replaceable Units" or "FRUs". Each FRU, Blade and Shelf Manager contain Intelligent Platform Management Controllers (IPMC) that communicate with each other through the Intelligent Platform Management Interface (IPMI) via a redundant pair of I2C buses.

## BACKPLANE

The ATCA backplane provides point to point connections (rather than a data-bus) for board to board communication. It is split into 3 zones; zone 1 at the bottom provides power and shelf management signals, zone 2 provides the connections to the base and fabric interfaces and zone 3 is for user defined signals and providing connectivity to the rear transition boards.

## BOARDS (BLADES)

ATCA blades can be Processors, Switches, or Carriers. Carriers support both PCI Mezzanine Cards (PMC) and Advanced Mezzanine Cards (AMC), the latter form the basis of the uTCA architecture. Blades are 6HP wide

## FEATURES

- Fully PICMG 3.0 Revision 2 compatible
- 6U high, 19" Rack-mounting chassis
- 6 slot ATCA front card area
- 6 slot ATCA rear transition module slots
- 40Gbps capable monolithic backplane design
- Triple replicated Full Mesh or Dual Star backplane topology options
- Power distribution for 300W+ per slot
- Provision for 4 x 850W AC-to-DC power supplies
- Power supply redundancy:
  - 2N and N+1 (with additional bridge board) for full mesh backplane
  - N+1 for dual star backplane
- Cooling capability 300W for front boards and 35W for RTM
- Four cooling zones: 2 front and 2 rear
- Two high pressure fan tray units, hot swappable, front pluggable
- Air filter mounted on fan tray unit, front pluggable
- Dual redundant Shelf FRU Data EEPROMs on the backplane
- Dual redundant IPMB (bussed topology)
- Provision for dual redundant shelf manager boards
- Pigeon Point SHMM500 shelf manager control
- RS232 and Ethernet control interfaces
- Front carry handle & rear cable tidy for easy install.
- ESD wrist strap point front and rear
- UL listed & designed to meet NEBS



A6R (6 Slot ATCA) Chassis – Front view



A6R (6 Slot ATCA) Chassis – Rear view

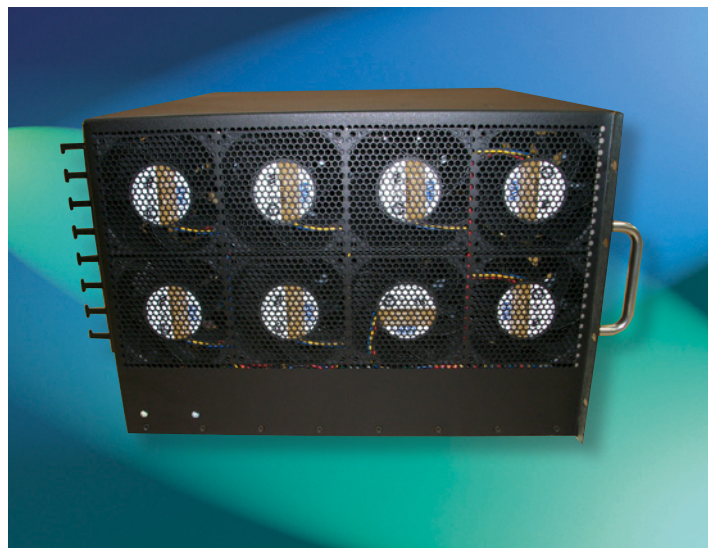

A6R (6 Slot ATCA) Chassis – Side view



# A6R – 6U 19" Rackmount ATCA Chassis

## SPECIFICATIONS

### Dimensions

Height = 265.9mm (10.47")  
 Width = 482.6mm (19")  
 Depth = 423.45mm (16.67") from 19" panel mounts to rear cable tray  
 42.7mm (1.68") from 19" panel mounts to front handle

### Weight

23KG (50.7lbs) (typical, 1 x power supply fitted)

### Material & Finish

Outer = Steel (Powder coated in black – textured finish)  
 Subrack = Steel (Zinc plated)

### Environmental

Operating Temperature = 0deg.C to +50deg.C  
 Storage Temperature = -20deg.C to +80deg.C  
 Cooling = 300W for front boards and 35W for RTM  
 (dependant on ambient temperature)

### Power Supply

Input = 90-264VAC, 47-63Hz  
 Output = -48V@17A  
 Active PFC = 0.99  
 EMI filter EN55022 Class B, FCC Part 15

## ORDERING INFORMATION

**260 - 4 2 1 0 X X X**

### BACKPLANE

6 Slot, Full Mesh 1  
 6 Slot, Dual Star 2

### POWER SUPPLIES

One 1  
 Two (N+1 configuration) 2  
 Two (2N configuration) 3  
 Three (N+1 configuration) 4  
 Three (2N configuration) 5  
 Four (N+1 configuration) 6  
 Four (2N configuration) 7

### SHELF MANAGERS

One 1  
 Two 2

## SPARES – ORDERING INFORMATION

Description	Qty	Ordercode
850W hot swap A6R power supply	1	260-4004709
64MB A6R shelf manager & controller	1	260-4004707
128MB A6R shelf manager & controller	1	260-4004708
A6R hot swap fan tray (with filter)	1	260-4004710
Filter media for A6R hot swap fan tray	1	260-4004711
A6R shelf manager filler panel	1	260-4004712
A6R power supply filler panel	1	260-4004713

## A6R CHASSIS – PHYSICAL FRU LAYOUT

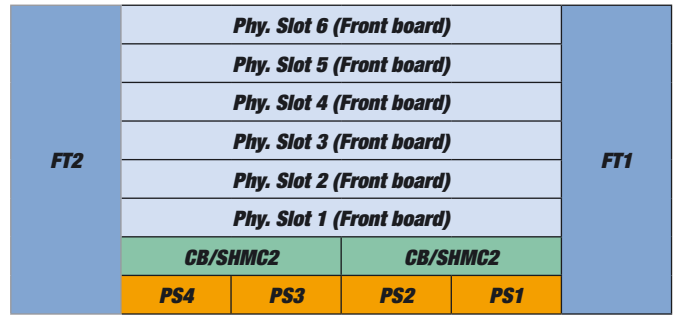

Figure 8 Front FRU Physical Layout

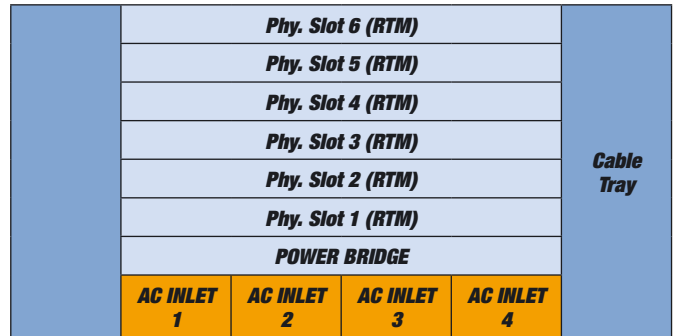
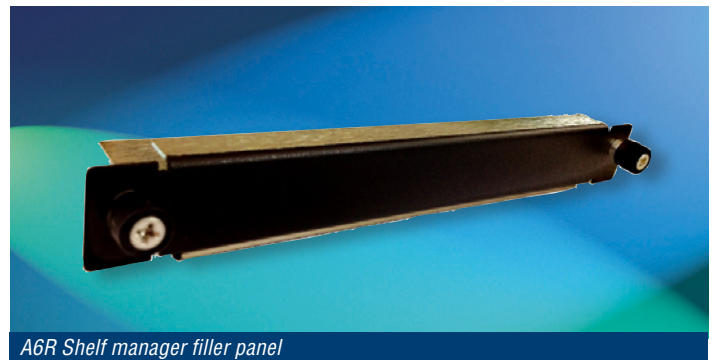

Figure 8 Front FRU Physical Layout



## DESIGN

Should you require an enclosure that does not fall within our standard range of products, VEROTEC can design, engineer and manufacture a special packaging solution for you. Using the latest in 3D Pro CAD software, we've worked with our customers to successfully bring to market a number of complex electro-mechanical products.

## MATERIALS & COMPONENTS

Such products often require the integration of moulded plastics, metal castings, formed sheet metal and a variety of electronic components such as PCBs, fans and PSUs. Our design engineers have many years of experience and a wealth of knowledge when it comes to material / component selection and manufacturing techniques. They work closely with the supply chain to ensure a cost effective and well engineered product.

## MARKETS & INDUSTRY STANDARDS

Our products are used in domestic, commercial and industrial applications and serve many different markets including military, medical, aviation, railway, telecoms, broadcast & electronics to name but a few. Each has a number of regulatory standards; knowledge of which is key in bring to market an industry compliant product. Verotec's design team and in-house compliance engineers can provide valuable information during the design and prototyping phases as well as undertaking pre-compliance safety testing for CE marking.

## ENVIRONMENTAL

Our manufacturing and engineering expertise in thermal management, EMC and power conversion means we can meet the most demanding design specifications whilst rising to the challenges of modern day environmental issues.

## MANUFACTURING & INTEGRATION

Verotec has fully equipped integration and test facilities that are ESD protected. Our skilled technicians provide a high degree of workmanship and quality.

## EXAMPLES

Some examples of products we have designed and manufactured are shown on this page.

### PHONE CHARGING KIOSK (BOXBRANDS)

This is a fairly large kiosk aimed at the commercial market which allows customers to charge their mobile devices. The manufacture & integration included:

- Heavy duty, vandal-proof, formed steel construction
- Secure, key lockable hinged compartments
- Overlays for graphics
- Coin accepting & storage devices
- PCB with GSM antenna
- ATX Power Supply
- Cable assemblies and management



### ICE SENSING UNIT (AIRBUS)

This product was designed and manufactured for a specific application onboard an Airbus aircraft. The design, manufacture and integration included:

- Very lightweight riveted aluminium construction
- Very tightly controlled tolerances
- Applicable aviation industry standards & specifications
- EMC and shock & vibration considerations
- Integrated IEC60297 subrack

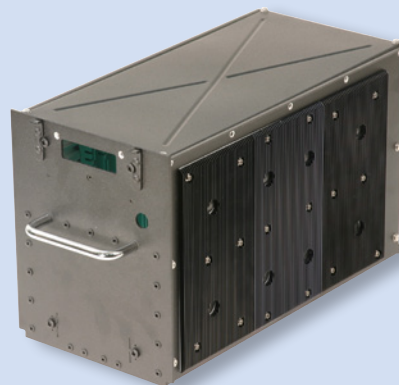

### SPECIAL FANTRAY (ERICSSON)

This product was designed and manufactured for a telecoms application. The design brief included:

- Cost engineered for high volume manufacture
- 19" applicable standards
- Removable fan functionality for serviceability



### MEDICAL CADBOX (AGFA)

This product serves as a PC enclosure for the medical market. The design and manufacture included:

- Custom moulded plastic parts
- ATX applicable standards
- Low cost engineering
- Specific packaging requirements

